

# Sonoma D12

---



---

# Sonoma D12 *IRU*

*Pgyqtm"Vkog"Ugtxgt"Wugt"Ocpwcn*

---

## About This Manual

Vjku" o cpwcn" yknn" i wkfg" {qw"vj tqwi j" uk o rng" kpuvcnncvkqp" cpf" ug" wr" r t q e g f w t g u }

Introduction N V j g" U q p q o c" F 3 4. " j q y" kv" y q t m u. " y j g t g" v q" w u g" kv. " kvu" o c k p" h g c v w t g u }  
Basic Installation N J q y" v q" e q p p g e v. " e q p L i w t g" c p f" v g u v" { q w t" U q p q o c" y k v j" { q w t" p g v y q t m }  
NTP Server and Client Set-Up N V y q" e n k g p v" u g e v k q p u= " q p g" h q t" W p k z/ n k m g" r n c v h q t o u" c p f" q p g" h q t" Y k p f q y u }  
Network Protocols - " E q x g t u" U g e w t k v { . " U P O R. " J V V R U. " K R x 8" c p f" R V R I K G G G / 3 7 : : }  
Console Port N F g u e t k r v k q p" q h" v j g" e q p u q n g" e q o o c p f u" h q t" w u g" q x g t" v j g" p g v y q t m" c p f" u g t k c n" r q t v u }  
Front-Panel Keypad and Display N J q y" v q" q r g t c v g" v j g" w u g t" k p v g t h c e g" v j c v" r t q x k f g u" e q p x g p k g p v" u g v w r" c p f" o q p k v q t k p i" q h" v j g" k p u v t w o g p v }  
Options N F g u e t k r v k q p" q h" c p { " q r v k q p c n" h g c v w t g u" v j c v" { q w t" U q p q o c" o k i j v" j c x g }

kh" { q w" f g v g e v" c p { " k p c e e w t c e k g u" q t" q o k u u k q p u. " r n g c u g" k p h q t o" w u } " G p f T w p" V g e j p q n q i k g u" e c p p q v" d g" j g n f" t g u r q p u k d n g" h q t" c p { " v g e j p k e c n" q t" v { r q i t c r j k e c n" g t t q t u" c p f" t g u g t x g u" v j g" t k i j v" v q" o c m g" e j c p i g u" v q" v j g" r t q f w e v" c p f" o c p w c n u" y k v j q w v" r t k q t" p q v k e g }

## Warranty

Vjku" r t q f w e v. " o c p w h c e v w t g f" d { " G p f T w p" V g e j p q n q i k g u. " k u" y c t t c p v g f" c i c k p u v" f g h g e v u" k p" o c v g t k c n" c p f" y q t m o c p u j k r" h q t" c" r g t k q f" q h" v j t g g" { g c t u" h t q o" f c v g" q h" u j k r o g p v. " w p f g t" p q t o c n" w u g" c p f" u g t x k e g } " F w t / k p i" v j g" y c t t c p v { " r g t k q f. " G p f T w p" y k n n" t g r c k t" q t" t g r n c e g. " c v" k v u" q r v k q p. " r t q f w e v u" y j k e j" r t q x g" v q" d g" f g / h g e v k x g } " R t q f w e v u" p q v" o c p w h c e v w t g f" d { " G p f T w p" V g e j p q n q i k g u" c t g" y c t t c p v g f" h q t" p k p g v { " f c { u" q t" n q p i g t. " c u" r t q x k f g f" d { " v j g" q t k i k p c n" g s w k r o g p v" o c p w h c e v w t g t. " h t q o" f c v g" q h" u j k r o g p v }

## Extended Warranty

Gp f T w p" r t q f w e v u" c t g" u w r r q t v g f" d { " c" u v t q p i. " e q o r t g j g p u k x g" u w c p f c t f" y c t t c p v { " \* u g g" r e t c i t c r j" c d q x g + 0 }  
G z v g p f g f" y c t t c p v k g u" c t g" c x c k n c d n g" v q" g z r c p f" v j g" e q x g t c i g" r g t k q f } " V j g" g z v g p f g f" y c t t c p v { " e c p" d g" r w t e j c u g f" c v" v j g" v k o g" q h" q t f g t. " q t" f w t k p i" v j g" n c u v" { g e t" q h" v j g" u w c p f c t f" y c t t c p v { " r g t k q f }

## Limitation of Warranty

V j g" h q t g i q k p i" g z r t g u u" y c t t c p v { " u j c m n" p q v" c r r n { " v q" f g h g e v u" t g u w n k p i" h t q o" k o r t q r g t" q t" k p c f g s w c v g" o c k p v g p c p e g" d { " D w { g t" q t" W u g t. " D w { g t / u w r r n k g f" u q h v y c t g" q t" k p v g t h c e k p i. " w p c w v j q t k | g f" o q f k L e c v k q p" q t" o k u w u g. " q r g t c v k q p" q w v u k f g" q h" v j g" g p x k t q p o g p v c n" u r g e k L e c v k q p u" h q t" v j g" r t q f w e v. " q t" k o r t q r g t" u k v g" r t g r c / t c v k q p" q t" o c k p v g p c p e g }

V Q " V J G" G Z V G P V" R G T O K V V G F" D [ " N C Y. " V J K U" Y C T T C P V [ " C P F" T G O G F K G U" U G V" H Q T V J" C D Q X G" C T G" G Z E N W U K X G" C P F" K P" N K G W" Q H" C N N" Q V J G T" Y C T T C P V K G U. " T G O G F K G U" C P F" E Q P F K V K Q P U. " Y J G V J G T" Q T C N" Q T" Y T K V V G P. " U V C V W V Q T [ . " G Z R T G U U. " Q T" K O R N K G F } " C U" R G T O K V V G F" D [ " C R R N K E C D N G" N C Y. " G P F T W P" U R G E K H K E C N N [ " F K U E N C K O U" V J G" K O R N K G F" Y C T T C P V K G U" Q H" O G T E J C P V C D K N K V [ " Q T" H K V P G U U" H Q T" C" R C T V K E W N C T" R W T R Q U G }

---

## Warranty Repair



---

Using netconfig to Set Up Your IP .....	11
Verify Network Configuration .....	12
Check Network Operation .....	14
Using Telnet .....	14
Using SSH .....	15
Using HTTPS .....	15
<b>Chapter Three - Network Time Protocol (NTP) .....</b>	<b>17</b>
<b>Configuring the NTP Server .....</b>	<b>17</b>
Configuring the Sonoma as a Stratum 1 Server .....	17
Configuring NTP Using the Front-Panel Keypad/Display .....	17
Configuring NTP Using the Network Interface or Serial Port .....	18
Configuring the Sonoma as a Stratum 2 Server .....	20
Edit ntp.conf File .....	20
Mask Alarm .....	21
<b>Setting Up NTP Clients on Unix-like Platforms .....</b>	<b>21</b>
Unix-like Platforms: Basic NTP Client Setup .....	22
Configure NTP .....	22
Unix-like Platforms: MD5 Authenticated NTP Client Setup .....	22
Create the ntp.keys File .....	23
Configure NTP .....	23
Unix-like Platforms: Broadcast/Multicast NTP Client Setup .....	







---

Firmware: Reboot Page .....	62
Disable or Restrict Access .....	62
<b>Chapter Eight - IPv6 .....</b>	<b>63</b>
IPv6 Capabilities .....	63
OpenSSH .....	63
Apache HTTP .....	63
Net-SNMP .....	63
NTP .....	64
IPv4-Only Protocols .....	64
<b>Chapter Nine - Console Port Control and Status .....</b>	<b>65</b>
Console Ports .....	65
General Linux Operation .....	65
Available User Commands .....	66
Detailed Command Descriptions .....	69
accessconfig .....	69
antfltmask .....	69
caldelay .....	69
cpuio (Optional) .....	70
cpuioconfig (Optional) .....	70
cpustat .....	70
faultstat .....	70
get_sw_opts .....	71
gpsdynmode .....	71
gpslastfix .....	71
gpsrefpos .....	71
gpsstat .....	71
gpstrkstat .....	73
gpsutcinfo .....	74
gpsversion .....	74
help .....	74
inetdconfig .....	



---

updaterootflag	84
updatekernelflag	84
upgradekernel	85
upgradercvr	85
upgradercvrfpga	85
upgraderootfs	85
upgradesubsys	86
wrt_sw_opt	86
<del>Chapter Ten</del> Options	87
Software N	M M M M M M M M M M M M M M M M M M

Sysplex Format . . . . .	93
Truetime Format . . . . .	94
EndRun Format . . . . .	94
EndRunX (Extended) Format . . . . .	95
NENA Format . . . . .	95
NMEA Format . . . . .	96
Power Supply Options . . . . .	100
DC Power Input . . . . .	100
Connecting the DC Power . . . . .	100
Dual-Redundant Power Supplies . . . . .	101
Masking Dual Power Supply Fault Alarms . . . . .	101
<b>Chapter Eleven - Front-Panel Keypad and Display . . . . .</b>	<b>103</b>
Display Description . . . . .	103
Keypad Description . . . . .	103
Display and Keypad Operation . . . . .	104
Traversing the Display Structure . . . . .	104
Editing . . . . .	104
Keypad EDIT Lockout . . . . .	105
Using Help . . . . .	105
Shortcut Menu . . . . .	105
Detailed Display Descriptions . . . . .	105
Time/Status . . . . .	105
Main Menu . . . . .	106
CPU Status . . . . .	106
Receiver Menu . . . . .	106
Receiver: Status (GPS Subsystem/Receiver Status) . . . . .	106
Receiver: Satellite Vehicle Information (SV_Info) . . . . .	107
Receiver: Reference Position (Ref_Pos) . . . . .	107
Receiver: Last Fix Position (Last_Fix) . . . . .	108
Receiver: UTC Information (UTC_Info) . . . . .	108
Receiver: Dynamic Mode (Dyn_Mode) . . . . .	108
Receiver: Oscillator Status (Osc_Stat) . . . . .	108
Receiver: Calibrate . . . . .	109

---

Faults Menu . . . . .	109
Faults: System . . . . .	109
Faults: Receiver . . . . .	109

---

Recovering from a Failed RFS Upgrade . . . . .	121
Performing the Linux Kernel Upgrade . . . . .	121
Transfer File to Sonoma . . . . .	121
Recovering from a Failed Kernel Upgrade	

---

Using Three Preamplifiers .....	138
Other Accessories .....	138
Lightning Arrestor .....	138
Signal Splitters .....	138
Calibrate Your Receiver .....	139
Mounting On A Rooftop .....	140
Mounting Inside A Window .....	141
Obtaining A Reference Position .....	141
Using a Handheld GPS Receiver .....	141
Using the Internet .....	141
About WGS-84 Height .....	142
Appendix F - Leap Seconds .....	147
Automatic Leap Second Insertion .....	147
Background Information .....	147
Appendix G - System Faults .....	149
Overview .....	149
Masking Faults .....	149
System Fault Definitions .....	149
Receiver Fault Definitions .....	151
Appendix H - Specifications .....	153
Special Modifications - Changes for Customer Requirements .....	161





ukqpu"ctg" o qpkvqtgf"htq o " i tqwpf"uvcvkqpu"nqecvfg"ctqwpf"vjg"y qtnf"cpf"ectghwmn{ " o gcuwtgf"tgnvcxg"vq" IRU"vk o g0"Vjg"tguwvu"qh"vjgug" o gcuwtg o gpvu"hqt"gcej"ucvgnkvg"ctg"vjgp"wrnqcf"gf"vq"vjcv"ucvgnkvg"uq" vjcv"vjg{" o c{"dg"kpqtrqtcvfg"kpqv"vjg"fcvc"eqpvckpgf"kp"kvu"vtcpu o kuukqpu0"Vjg"tgegkxgt"ecp"wug"vjku" fcvc"vq"tgnvcg"vjg"vk o g/qh/cttkxcn"qh"vjg"tgegkxgf"vtcpu o kuukqpu"htq o "vjcv"ucvgnkvg"vq" IRU"vk o g0

Cnn"qh"vjku" o gcpu"vjcv"fwtkpi"pqt o cn"qrgtcvkqp."vjg"uqwtg"qh"vjg"vk o kpi"kphqt o cvkqp"dgkpi"vtcpu o kvwgf" htq o "gcej"qh"vjg"ucvgnkvgu"ku" fktgevn{"vtcegcdng"vq"WVE0" Fwg"vq"vjg"pcvwtg"qh"vjg" IRU"urtgcf/urges/ vtw o " o qfwncvkqp"uejg o g."vjku"vk o kpi"kphqt o cvkqp" o c{"dg"gzvtcevgf"d{"c"y gnm/fgukipgfi"tgegkxgt"ykvj"c" r tgekukqp"qh"chgy"pcpqugeqpfu0"Vjg" IRU"Uwdu{uvg o "kp"vjg"Uqpq o c"fqgu"lwuv"vjcv0

### GPS Receivers

IRU/dcugf"vk o kpi"u{uvg o u"ur rqtvkpi"etkvekn"kphtcuvtwevwtg"eqwnf"dg"xwnpgtcdng"vq" o cnhwpevkqp"fwg" vq"y gcm"uki pcnu."lc o o kpi."urqqŁpi"qt"ceekfgpvcn" IRU"eqpytan"u{uvg o "gttqtu0"Rtqrktgvct{"cni qtkvj o u" kp"Uqpq o c"rgthqt o "cfxcpegf"kpvg i tkv{"ej gemu"vq"Łnvg"tcpfq o "cpf"rgtukvpgp"gttqtu"vq"vjg" IRU"uwd/ htc o g"fcvc0"

GpfTwp"fgxgnqrgf"c"vk o kpi"qrvk o k|gf" IRU"tgegkxgt"htq"cf flvkqpcn"tgukngpe{"ceewtce{"cpf"tgnkcdknkv{0" Vjg"GpfTwp" IRU"tgegkxgt"uvtkevn{"eq o rnkgu"vq"vjg"KU/ IRU/422"urgekŁecvkqp0"cpf"dgicp"ujkr rkp i "kp" Uqpq o c"kp"Lwpg"42390" IRU"tgegkxgt"urgekŁecvkqp"ctg"nkuvgf"kp" 0

## Time Synchronization Components

Vjg"Uqpq o c"ku"eq o rqugf"qh"c" Inqdcn"Rqukvkqkpi"U{uvg o "\*"IRU+"Uwdu{uvg o "eqpvckkpi"vjg"GpfTwp" IRU"tgegkxgt"cpf"u{uvg o "queknvcvt0"Vjg" IRU"Uwdu{uvg o "ku"kpvg i tcvgf"ykvj"chcpnguu."eqpxgevqp/ eqqngf"304" I J |"ERW"ykvj"v y q"kpvg i tcvgf"Gvjgtpgv"rtqv"vjcv"rtqxfkfg"PVR"\*cpf"qrvkqpcn{"RVR+0" Vjku"ku"ecmgf"vjg"Nkpwz|PVR"Uwdu{uvg o 0"Vjg"ftc y kpi"dgng y"ujq y u"Uqpq o c"u"vk o g"u{pej tqpk|cvkqp" eq o rqpgev0

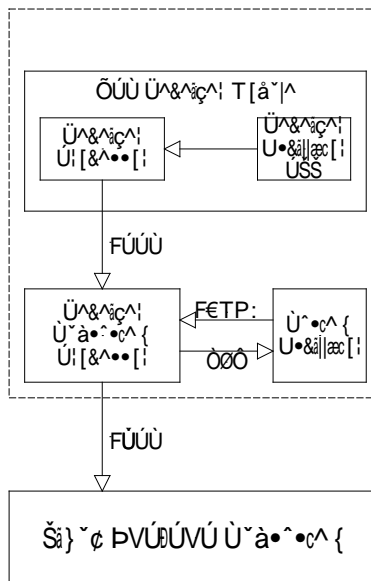

---

## Where to Use It

Ukpeg"uki pcnu"htq o "vjg" IRU"ucvgnkvgu"ctg"cxckncdng"cv"cn"nqecvkqpu"qp"vjg"inqdg."{qw"oc{"fgrnq{"vjg"  
Uqpq o c"xktvwenn{"cp{y jgtg0""J qy gxtg."{qw"o wuv"dg"cdng"vq"kpucnn"cp"cpvgppc"gvjgt"qp"vjg"tqqhvqr"qt"  
kp"c"ykpfaqy"uq"vjcv"ucvgnkvg"vtcpu o kuukqpu"oc{"dg"tgegkxgf"cv"ngcu"ugxgtcn"vk o gu"fwtkpi"vjg"fc{0""Hqt"  
o qtg"kphqt o cvkqp"ugg" 0

Qpeg"u{pe j tqpk |gf."vjg"Uqpq o c"ecp"o ckpvc"ceegrvc"pgv y qtm"u{pe j tqpk |cvkqp"ceewtce{"hqt"  
cdqww"cf{"ykvjqww"IRU"tgegrvkqp."d{"f{y jggkpi"qp"kvu"uvcpfctf"vg o rgtcvwtg"eq o rgpucvgt"et{uvcn"  
quekncvqt"\*VEZQ+0""Vjg"VEZQ"gpwtgu"46/jqwt"jqnfqxtg"rgtkqf"ykvjqww"c"IRU"uki pcn0""Hqt"nqpi gt"  
jqnfqxtg"rgtkqfu"qh"57"fc{u"qt"o qtg."cp"quekncvqt"wr i tcf g"oc{"dg"kpucnngf"kp"qwt"Uqpq o c0

## Client / Slave Software

Vjg"Uqpq o c"jcu"dgpp"fgukipgf"vq"qrgtcvg"kp"eqplwpevkqp"ykvj"gzkuvki"rwdnke"fq o ckp"PVRIUPVR"enk/  
gpv"uqhv y ctg"cpf"oc{"dg"wugf"kp"cp{"pgv y qtm"gpxtqpo gpv"vjcv"ku"wukpi"VERIKR"rtqvqeqnu0""Cnvjqwi j"  
enkpp"uqhv y ctg"ku"cxckncdng"ht"cm"rncvht o u."hqt"vjg"o quv"rtgekug"cr rncecvkqpu."vjg"Wpkz/nkmg"qrgtcvki"  
u{uvg o u"ctg"dguv"uwr r qtvgtf0""Hqt"o qtg"kphqt o cvkqp"ugg"

"cpf"

0""Vjgtg"ku"cf fkvkqpcn"kphqt o cvkqp"cdqww"

PVR"Enkpp"uqhv y ctg"cv"v jku"nkpm<

" gpfwtpvge j pqi i kguleq o lrtqfwewulpvr/vk o g/ugtxgtulpvr/enkpp/uqhv y ctg

Hqt"RVRlKGGG/37: : "cr rncecvkqpu."vjg"Uqpq o c"ecp"kpvgtqrgtcvg"ykvj"c"xctkgy{"qh"Uncxg"uqhv y ctg"cpf"  
jctf y ctg0""Hqt"o qtg"kphqt o cvkqp"qp"RVR"Uncxg"Uqhv y ctg" i q"vq"v jku"nkpm<

" gpfwtpvge j pqi i kguleq o lrtqfwewuli tcpf o cuvgt/enqemulr vr/uncxgu

Vjku"rcig"kpvgpvkqpcm{"nghv"dncpm0



Sonoma Physical  
Description

U{pe"NGF" "	"	Vjku"co dgt"NGF" fcu jgu"vq"kp fkecvg"u {pej tqpk  cvkqp"uvcvwu0
Cnct o"NGF"	"	Vjku"tgf"NGF"knw okpcvgu"dtkg f { "cv"rq ygt/wr."cpf"vjgtgchvgt"y jgpgxgt
" " "	"	c"ugtkquw"hcwnv"eqp fkvkqp"gzkuvu0

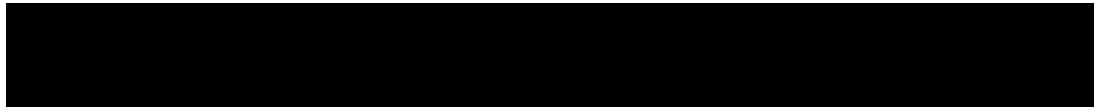



## Installing the Sonoma

FCC NOTICE



kh{qwt"pgv y qtm"fggu" wug" F J ER" hqt" j quv" eqpŁ i wtcvkqp." cpf" {qw" ctg" kp" c" j wtt" { "vq" i g v" {qwt" Uqpq o c" wr" cpf" twppkpi." {qw" o c" { "rtqeggf" vq" "vq" o cmg" uwtg" v j cv" v j g" p g v y qtm" rctc o g vgtu" y gtg" ugv" wr" eqttgevn" {0"" Qv jgt y kug." kv" ku" tgeq o o gp f g f" v j cv" {qw" tgc f" v j g" hqmq y kpi" ugevkqpu" qp" v j g" wug" qh" v j g" TU/454" ugtkcn" KlQ" r qtv" p q y." ukpeg" v j g" { "y knn" j gnr" {qw" kp" fg d w i i kpi" cp" { "r tq d ng o u" v j cv" {qw" o c" { "gpeqwpvgt" y kv j" v j g" c w v q o c vke" eqpŁ i wtcvkqp" xkc" F J ER}

kh{qwt"pgv y qtm"fggu" pqv" wug" F J ER." {qw" y knn" pggf" vq" eqpŁ i wtg" {qwt" Gv j gtpgv" kpvgthcegu" wukpi" "gkv jgt" v j g" htqp v/ rcp gn" mg { r c f" qt" v j g" TU/454" ugtkcn" KlQ" r qtv" V j g" hqmq y kpi" ugevkqpu" eqpvckp" dtkgh" f g uetkr/ vkqpu" qp" j q y" vq" f q" v j cv}

### Configuring Ethernet with the Front-Panel Keypad

EqpŁ i wtkpi" {qwt" Gv j gtpgv" kpvgthcegu" y kv j" v j g" htqp v/ rcp gn" mg { r c f" ku" swkv g" uk o r ng" Chvgt" v j g" wpkv" j cu" r q y gtg f" qp." r tguu" v j g" GP VGT" mg { "qpeg" qt" v y keg" wpvkn" {qw" ugg" c" fkurnc" { "ecmgf" Ockp" Ogpw" P q y" r tguu" v j g" TK I J V" cttq y" mg { "wpvkn" v j g" P g v y qtm" ugngevkqp" ku" j ki j nk i j v g f" V j g p" j ki j nk i j v" gkv jgt" P g v/ y qtm" 6" qt" P g v y qtm" 8" cpf" r tguu" GP VGT" ci ckp" P q y" {qw" ecp" e j qqug" y j ke j" r qtv" vq" ugv" wr" /" gkv jgt" f u i . 1" qt" f u i 2" [qw" y knn" v j g p" dg" cdng" vq" uvctv" o q f kh" {kpi" v j g" KR" c f f tguu." i cvg y c" { "cpf" p g v o cum" d" { " r tguu kpi" v j g" G F K V" mg { 0"" V j g" u g s w g p e g" qh" f k u r n c" {u" y knn" i w k f g" {qw" v j t q w i j" v j g" u g v w r" r t q e g u u" R t g u u" v j g" J G N R" mg { "cv" cp" { "vk" o g" vq" xkg y" eqpvgzv/ ugpukvxg" j gnr" kphqt o cvkqp" Y j g p" {qw" ctg" Łpkujgf" e j qqug" v j g" T G D Q Q V" o g p w" kv g o" cpf" kpkvkv g" c" u" {uvg o" tgdqqv" }

### Configuring Ethernet with the Serial Port

Vq" eqpŁ i wtg" {qwt" Gv j gtpgv" kpvgthcegu" y kv j" v j g" ugtkcn" r qtv." chvgt" nq i i kpi" kp" cu" v j g" tq q" wugt." {qw" o wuw" twp" c" uk o r ng" uetkrv" ecmgf" ofudpogj h" V j ku" uetkrv" y knn" r tq o r v" {qw" hqt" v j g" pggf g f" kphqt o cvkqp" cpf" r gthqt o" uq o g" u" {pvcz" e j gemkpi" qp" {qwt" kpr wvu" V j g p" v knn" etgcvg" qt" o q f kh" { "v j g" c r r tq r tkcv g" Łngu" pggf g f" vq" eqpŁ i wtg" v j g" Gv j gtpgv" kpvgthcegu" V j g" hqmq y kpi" ugevkqpu" y knn" i w k f g" {qw" kp" ugvkpi" wr" eq o / o wpkcvkqpu" y kv j" v j g" Uqpq o c" wukpi" kvu" TU/454" ugtkcn" KlQ" r qtv}

#### Connect the RS-232 Serial I/O Port

Vq" vguv" ugtkcn" eq o o wpkcvkqpu" y kv j" v j g" Uqpq o c" {qw" y knn" pggf" gkv jgt" c" XV322" eq o r cvkdng" vgt o kpcn" qt" c" vgt o kpcn" g o wncvkqp" r tq i tc o" twppkpi" qp" {qwt" eq o r wvgt" Y g" y knn" tghgt" vq" gkv jgt" qh" v j g u g" cu" o vgt o k/ pcn" hqt" v j g" tg o ckp fgt" qh" v j ku" kpuvtwevkqp}

30" Fkueqppgev" r q y gt" htq o" v j g" Uqpq o c}

40" Eqppgev" qpg" gp f" qh" v j g" FD; H/vq/ FD; H" pwnn" o q f g o" c f c r vgt" ecdng" vq" v j g" ugtkcn" KlQ" l cem" qp" v j g" Uqpq o c}

50" Eqppgev" v j g" qv jgt" gp f" qh" v j g" FD; H/vq/ FD; H" pwnn" o q f g o" c f c r vgt" ecdng" vq" v j g" vgt o kpcn" Kh" v j g" ugtkcn" KlQ" r qtv" qp" {qwt" vgt o kpcn" f qgu" p qv" j c x g" c" FD; O" eqppgevqt." {qw" o c" { "pggf" vq" wug" cp" c f c r vgt" Tghgt" vq" "hqt" f g v c k n n" qp" v j g" u k i p c n" y k t k p i 0"" Kh" {qw" ctg" wukpi" c" eq o r wvgt" hqt" {qwt" vgt o kpcn." t g o g o d g t" y j k e j" r q t v" {qw" ctg" wukpi" d g e c w u g" {qw" y knn" pggf" vq" m p q y" v j cv" kp" q t f g t" vq" u g v" w r" {qwt" vgt o kpcn" u q h v y c t g}

Test the Serial Port

```
[qw"o wuv"eqpŁi wtg" {qwt"vgt o kpcn"vq" wug"vjg"ugtkcn"klQ" rqtv" {qw" wugf"kp"
"cdqyg0" [qw"o wuv"cnuq"eqpŁi wtg" {qwt"vgt o kpcn"cu"ujqy p"dgnqy<
```

É" Dcwf" Tcvg<"3;422

É" Fcvc" Dkvu<" :

É" Rctkv{<"Pqpg

É" Uvqr" Dkvu<"3

É" Jcpfujcmkpi"l"Hnqy"Eqpvtqn<"QHH"\*dqvj"jctfyctg"cpf"uqhvyctg+

É" Vgt o kpcn"G o wncvkqp"\*kh"cp{+<"XV322"\*qt"uk o knet+"qt"Nkpwz

Chvgt"eqpŁi wtkpi"vjgug"rctc o gvgtu"kp" {qwt"vgt o kpcn."cr rn{"r qygt"vq"vjg"Uqpq o c0"Chvgt"cdqww"42"



```

+++++
+++++Tpopnb`E23!HQT!JQW50JQW7!Ofuxpsl!Dpogjhvsbu jpo!+++++
+++++
+!!!!!!!!!!!!!!!!!!!!!!!!!!!!!!!!!!!!!!!!!!!!!!!!!!!!!!!!!!!!!!!!!!!!!!!!!!!!+
+!!!Ui jt!tds jqu!xjmm!dpogjhvsf!uif!UDQ0JQW50JQW7!ofuxpsl!qbsbnfufst!gps!zpv s!!+
+!!!Tpopnb`E23!HQT/!!Xf!xjmm!gjstu!dpogjhvsf!JQW5!boe!uifo!JQW7/!!Zpvs!!!!!!!!!!+
+!!!Tpopnb`E23!HQT!ibt!uxp!fui fsofu!joufsgbdf t-!dbmmfe!fui1!boe!fui2/!!Gps!!!!+
+!!!fbdi!pg!JQW5!boe!JQW7-!xf!xjmm!gjstu!dpogjhvsf!fui1!boe!uifo!fui2/!!!!!!!!!!+
+!!!!!!!!!!!!!!!!!!!!!!!!!!!!!!!!!!!!!!!!!!!!!!!!!!!!!!!!!!!!!!!!!!!!!!!!!!!!+
+!!!Zpv!dbo!dipptf!up!lffq!uif!fyjtu joh!dpogjhvsbu jpo!pg!fjuifs!joufsgbdf!boe!+
+!!!sfdpogjhvsf!uif!pui fs/!!Zpv!dbo!bmt p!dipptf!up! vodpogjhvsf!fjuifs!pg!!!!+
+!!!uif!uxp!joufsgbdf t!jg!cpui!bsf!opu!offefe!jo!zpv s!bqmqjdbu jpo/!!!!!!!!!!+
+!!!!!!!!!!!!!!!!!!!!!!!!!!!!!!!!!!!!!!!!!!!!!!!!!!!!!!!!!!!!!!!!!!!!!!!!!!!!+
+!!!Zpv!xjmm!cf!bcmf!up!sfdpogjhvsf!zpv s!tztufn!bu!boz!ujnf!cz!uzqjoh;!!!!!!+
+!!!!!!!!!!!!!!!!!!!!!!!!!!!!!!!!!!!!!!!!!!!!!!!!!!!!!!!!!!!!!!!!!!!!!!!!!!!!+
+!!!ofudpogjh!!!!!!!!!!!!!!!!!!!!!!!!!!!!!!!!!!!!!!!!!!!!!!!!!!!!!!!!!!!!!!!!!!!!+
+!!!!!!!!!!!!!!!!!!!!!!!!!!!!!!!!!!!!!!!!!!!!!!!!!!!!!!!!!!!!!!!!!!!!!!!!!!!!+
+!!!Uif!tfuujoht!zpv!nblf!opx!xjmm!opu!ublf!fgg fdu!voujm!zpv!sfcp pu!zpv s!!!!!!+
+!!!Tpopnb`E23!HQT-!tp!jg!zpv!nblf!b!n j tublf-!kvtu!sf.svo!ui jt!tds jqu!cfgpsf!!+
+!!!sfcp pu joh/!!!!!!!!!!!!!!!!!!!!!!!!!!!!!!!!!!!!!!!!!!!!!!!!!!!!!!!!!!!!!!!!!!!!+
+!!!!!!!!!!!!!!!!!!!!!!!!!!!!!!!!!!!!!!!!!!!!!!!!!!!!!!!!!!!!!!!!!!!!!!!!!!!!+
+!!!Zpv!xjmm!cf!qspnqufe!up!foufs!zpv s!JQW50JQW7!ofuxpsl!qbsbnfufst!opx/!!!!!!+
+!!!!!!!!!!!!!!!!!!!!!!!!!!!!!!!!!!!!!!!!!!!!!!!!!!!!!!!!!!!!!!!!!!!!!!!!!!!!+
+++++
+++++

```

```

Dpogjhvsf!JQW5!gps!fjuifs!fui1!ps!fui2@
!!)Botxf s!zft!up!dpoujovf!po!boe!sfdpogjhvsf!fjuifs!fui1!ps!fui2!gps!JQW5/*
!!)Botxf s!op!up! vodpogjhvsf !cpui!fui1!boe!fui2!gps!JQW5/!!Pomz!uif
!!!JQW5!mppqcbd1!joufsgbdf!xjmm!cf!tfuvq/*!)\z^ft-!\o^p*;

```

Chvgt"eqpLiwtkpi" {qwt"Gvjgtpgv"kpvgthcegu." {qw"ujqwnf"ujwvfqyp"vjg"Uppqoc"cpf"tgdqqv"kv"d {"kuwkp i" vjku"eqo ocpf"cv"vjg"rtqo rvc

Tpopnb!E23!HQT) sppuATpopnb`E23;!\*.\*?!sfcp pu

### Verify Network Configuration

kh" {qw"ctg"wukpi"vjg" TU/454"ugtkcn"klQ"rqtv"vq"eqo o wpkcev g"ykvj"vjg"Uppqoc." {qw"ykn"dg"cdng"vq"ugg"

kh{qw"ctg"pqv"wukpi" F J ER"vjg"KR"cfftguu"ujqyp"ujqwnf" ovej"vjg"uvcvke"KR"cfftguu"y jkej" {qw"
gpvgtgf"fwtkpi"vjg"ofudpogjh"rtqegfwtg"kh"uq."nqi"kp"cu"otqqv"ö"cv"vjg"nqikp"rtqo"rv"cpf"ejgem"vjg"
qvjgt"eqpLiwtcvkqp"rtcogvgtu"wukpi"jgd pogjh<

Tpopnb!E23!HQT) sppuAiptu; ;\* . ? ! jgd pogjh

fui1!!!!!!Mjo1!fodbq;Fuifsofu!!IXbees!11;1f;gf;12;11;2d
!!!!!!!!!!jofu!bees;2:3/279/2/231!!Cdbtu;2:3/279/2/366!!Nbt1;366/366/366/1
!!!!!!!!!!VQ!CSPBEDBTU!SVOOJOH!NVMUJDBTU!!NUV;2611!!Nfusjd;2
!!!!!!!!!!SY!qbdlfut;:7:5!fsspst;1!espqqfe;:81!pwfssvot;1!gsbnf;1
!!!!!!!!!!UY!qbdlfut;56:!fsspst;1!espqqfe;1!pwfssvot;1!dbssjfs;1
!!!!!!!!!!dpmmjtjpot;1!uyrvfvfmfo;2111
!!!!!!!!!!SY!czuft;93:916!)921/4!LjC\*!!UY!czuft;61353!)5:/1!LjC\*
!!!!!!!!!!Joufssvqu;22

fui2!!!!!!Mjo1!fodbq;Fuifsofu!!IXbees!11;1f;gf;12;11;2e
!!!!!!!!!!jofu!bees;2:3/279/6/2!!Cdbtu;2:3/279/6/366!!Nbt1;366/366/366/1
!!!!!!!!!!VQ!CSPBEDBTU!SVOOJOH!NVMUJDBTU!!NUV;2611!!Nfusjd;2
!!!!!!!!!!SY!qbdlfut;21254!fsspst;1!espqqfe;:81!pwfssvot;1!gsbnf;1
!!!!!!!!!!UY!qbdlfut;1!fsspst;1!espqqfe;1!pwfssvot;1!dbssjfs;1
!!!!!!!!!!dpmmjtjpot;1!uyrvfvfmfo;2111
!!!!!!!!!!SY!czuft;992192!)971/5!LjC\*!!UY!czuft;1!)1/1!C\*
!!!!!!!!!!Joufssvqu;26

mp!!!!!!Mjo1!fodbq;Mpdmb!Mppqcbd1
!!!!!!!!!!jofu!bees;238/1/1/2!!Nbt1;366/1/1/1
!!!!!!!!!!jofu7!bees;!; ;20239!Tdpqf;Iptu
!!!!!!!!!!VQ!MPPQCBDL!SVOOJOH!!NUV;27547!!Nfusjd;2
!!!!!!!!!!SY!qbdlfut;6919!fsspst;1!espqqfe;1!pwfssvot;1!gsbnf;1
!!!!!!!!!!UY!qbdlfut;6919!fsspst;1!espqqfe;1!pwfssvot;1!dbssjfs;1
!!!!!!!!!!dpmmjtjpot;1!uyrvfvfmfo;1
!!!!!!!!!!SY!czuft;839289!)822/2!LjC\*!!UY!czuft;839289!)822/2!LjC\*

Re{ "rctvkewnet"cvgpykqp"vq"vjg"ugvvpki"u"ujqyp"hqt" fui1"cpf" fui2."kp"rctvkewnet"vjg"Nbt1<"ugvvpki."
y jkej"ujqwnf" ovej"vjcv"y jkej"ku"cr rtqr tkcvg"hqt" {qwt"pgvy qtm" Pqy"ejgem"vjg"tg o c k p k p i " e q p L i w t c /
vkqp"rtcogvgtu"wukpi"spvuf<

Tpopnb!E23!HQT) sppuAiptu; ;\* . ? ! spvuf

Lfsofm!JQ!spvujoh!ubcmf
Eftujobujpo!!!!!!Hbufxbz!!!!!!!!!!Hfonbt1!!!!!!!!!!Gmbht!Nfusjd!Sfg!!!!!!Vtf!Jgbd f
efgbvmu!!!!!!!!!!2:3/279/2/2!!!!!!!!!!1/1/1/1!!!!!!!!!!VH!!!!!!2!!!!!!!!!!1!!!!!!!!!!1!fui1
mppqcbd1!!!!!!!!!!+!!!!!!!!!!!!!!!!!!!!!!!!!!366/1/1/1!!!!!!!!!!V!!!!!!!!!!1!!!!!!!!!!1!!!!!!!!!!1!mp
mpdbmofu!!!!!!!!!!+!!!!!!!!!!!!!!!!!!!!!!!!!!366/366/366/1!!!!!!V!!!!!!!!!!1!!!!!!!!!!1!!!!!!!!!!1!fui1
2:3/279/6/1!!!!!!!!!!+!!!!!!!!!!!!!!!!!!!!!!!!!!366/366/366/1!!!!!!V!!!!!!!!!!1!!!!!!!!!!1!!!!!!!!!!1!fui2

Jgtg{qw"ctg"kpvgtguvf"kp"vjg"fgcwnv"icvgy c{ "cfftguu"Kv"ujqwnf" ovej"vjg"cr rtqr tkcvg"qpg"hqt" {qwt"
pgvy qtm"Kh"uq."vjgp"vjg"Gvjgtpgv"kpvgthceg"qh" {qwt"Uappq o c" jcu"dgpp"uweeguuhwnm{ "eqpLiwtgf"vq"qrgt/
cvg"qp" {qwt"pgvy qtm"cpf" {qw"ctg"tgcf{ "vq"ejgem"qrgtckvq"qh"vjg"Uappq o c"qxgt"vjg"pgvy qtm"Kh"pqv."
{qw"ujqwnf"tgejgem" {qwt"eqpLiwtcvkqp"cpflqt"tgrgc v"vjg"ofudpogjh"rtqegfwtg)

kh{qw"jcxg"eqpLiwtgf" c"pcogugtxgt\*u+"hqt" {qwt"pgvy qtm." {qw"oc"ejgem"vjcv"d{ "kuuwpki"vjku"eqo/
ocpf<

Tpopnb!E23!HQT) sppuAiptu; ;\* . ? ! dbu!0fud0sftpmw/dpog
tfbsdi!zpvse/epnbjo
obnftfswfs!2:3/279/2/2
obnftfswfs!2:3/279/2/3

Y jkej "fku rnc {u"vjg"eqpvpgpvu"qh"vjg"lgvel tguqxndleqph"Łng"eqpvckpkpi "vjg"fq o ckp"pc o g" {qw"gpvtgfg"rtgkx/  
qwu n {"wukpi "ofudpogjh."cpf"vjg"pc o gugtugt"KR"cf f tguu\*gu+"vq"wg"hqt"vjcv"fq o ckp}

### Check Network Operation

Y kvj {"qwt"Uppq o c"pgv y qtm"rtc o gygtu"rtqrtn {"eqpŁi wtgf." {qw"ctg"tgc f {"vq"vguv"vjg"ugvwr" wukpi "  
qjoh"htq o "c"ugtugt"qt" y qtmuvckqp"vjcv"ku"cdng"vq"ceeguu"vjg"pgv y qtm"eqppgevgf"vq"vjg"Uppq o c" Cn/  
vgtpcvkxgn {" {qw"eqwnf"qjoh"ppg"qh" {qwt"ugtugt"qt" y qtmuvckqpu"htq o "vjg"Uppq o c"rtq o rv"vq"vguv"vjg"  
ugvwr}

Qpeg {"qw"jcxg"uweeguuhwn {"guvcdnku jgf"pgv y qtm"eq o o wpkcvkqpu" y kvj"vjg"Uppq o c." {qw" o c {"rgthqt o "  
cnn" o ckpvpcpeg"cpf" o qpkvqtkpi "cevkxkvku"xc"ufmofu"cpf"guq" Vjg"Uppq o c"rtqxfgu"dvj"enkpv"cpf"  
ugtugt"qrgtcvkqp" wukpi "ufmofu" Hqt"ugewtkv {"tgcuppu."qpn {"enkpv"qrgtcvkqp"ku"uw r rqtvgf" wukpi !guq"  
 [qw" o c {"cnuq" o qpkvt"vjg"Uppq o c"xc"vjg" J VVRU"kpvgthceg"\*ugg" +}

Ugewtkv {"eqpuekqu" wugtu" y knn" y cpv"vq"wg"ttt."vjg"ugewtg"ujgmn"tg rnceg o gpv"hqt"ufmofu."cu"vjg"nqi"kp"  
 o gcpu" Vjg"eq o rcpkp" wvknkv {"tdd"rtqxfgu" c"ugewtg"tg rnceg o gpv"hqt"guq"cu" c" o gcpu"qh"vtcpuhgttkpi "  
 Łngu"vq"cpf"htq o "vjg"Uppq o c" Dqvj"qh"vjgug"rtqvqeqnu"ctg"uw r rqtvgf"kp"vjg"Uppq o c"xc"vjg"QrgpUUJ "  
 k o rng o gpvcvkqpu" hqt"Nkpwz" Tghg"vq" "hqt" o qtg" kphqt o cvkqp"cdqvw"vjg"  
ugewtg"ujgmn"rtqvqeqn}

### Using Telnet

Y jgp"guvcdnku jkpi "c"ufmofu"eqppgevkqp" y kvj {"qwt"Uppq o c."nqi i kpi "kp" fktgevn {"cu"tqqv"ku"pqv"rgt o kv/  
vgf" Vjku"ku" c"ugewtkv {" o gcuwtg"vjcv" o cmgu"kv"unki jvn {" o qtg" fkhŁewnvq" i ckp"ceeguu" d {"uk o rn {"vt {"kpi "  
rcuu y qtfu."ukpeg"kv"ku"cnuq"pgeguuct {"vq"mpqy"vjg"pc o g"qh" c"wgut" Y jgp {"qw"kpvcvq" c"ufmofu"uguukqp"  
 y kvj"vjg"Uppq o c."vjku"dcppgt" y knn"dg" fku rnc {gf<

```
+++++
+!!!!!!Xfmdpnf!up!Tpopnb`E23!HQT!ufmofu!dipotpmf!po;!!iptu/zpvs/epnbjo
+++++
```

iptu!mphjo;

Jgtg {"qw" o c {"nqi"kp"cu"öpv rwugt" y kvj "rcuu y qtf"öRtcgekuö" Y jgp"nqi i g f"kp"cu"öpv rwugtö." {qw" o c {"  
ejgem"uvcvw" kphqt o cvkqp"cpf" xky"nqi "Łngu"dwv {"qw" y knn"pqv"dg"cdng"vq" o qfkh {"cp {"u {"uvg o "ugwkp i u"qt"  
xky"ugewtg"Łngu" Chvg"eqttgevn {"gpvgtkpi "vjg"rcuu y qtf"cv"vjku"rtq o rv.

Qbttxpse;

vjg"uki p"qp" o guuci g"ku"ujq y p"kv"kf gpvkŁgu"vjg" jquv"u {"uvg o "cu"Uppq o c" IRU"cpf"ujq y u"vjg"uqh v y ctg"  
rctv"pw o dgt."xgtukqp"cpf"dwknf"fcvg<

```
Tpopnb`E23!HQT!7121.1176.111!w!2/11!Tbu!Kbo!2: !25;28;55!VUD!3124
Tpopnb`E23!HQT!)sppuAiptu;!*.*?
```

Vjku"ncuv"nkpg"ku"vjg"uvcpfctf"Uppq o c" IRU"rtq o rv" Chvg"eqpŁi wtkpi "vjg"wpkv." {qw"ujqwnf"ejcpi g"vjg"  
rcuu y qtfu" wukpi "vjg"Nkpwz"qbttxe"eq o o cpf"kuuwgf"htq o "vjg"rtq o rv}

Vq" i ckp"tqqv"ceeguu." {qw" o wuv"pqy"kuuwg"vjg"öuwr g t" wugtö"eq o o cpf"cv"vjg"rtq o rv<



Vjku"rcig"kpvgpvkqpcnn{"nghv"dncpm0







Foufs!b!lfz!ovncfs!)2.76645\*!ps!1!up!rvju;!!3

Foufs!uif!lfz!)2.42!BTDJJ!dibsbdufst\*;!!Tpopnb

Xsjujoh!lfz!ovncfs;!3!boe!Lfz;!Tpopnb!up!ouq/lfzt

Foufs!b!lfz!ovncfs!)2.76645\*!ps!1!up!rvju;!!1

...OUQ!Bvuijoujdbujpo!Dpogjhvsbujpo

Ep!zpv!xbou!bvuijoujdbujpo!fobcmfe!vtjoh!tpnf!ps!bmm!pg!uif!lfzt!jo  
uif!ouq/lfzt!gjmf@!)\z^ft-!\o^p\*!!z

Zpv!xjmm!cf!qspnqufe!gps!uif!lfz!ovncfst!)2!.!76645\*-!uibu!zpv!xbou!OUQ!up  
usvtu /!!Uif!lfz!ovncfst!zpv!foufs!nvtu!fyjtu!jo!zpv!ouq/lfzt!gjmf/!!Jg!zpv  
ep!opu!xbou!up!vtf!tpnf!pg!uif!lfzt!jo!zpv!ouq/lfzt!gjmf-!ep!opu!foufs!uifn  
ifs/!!OUQ!xjmm!usfbu!uiptf!lfzt!bt! vousvtufe /

Dmjfout!uibu!vtf!boz!pg!uif! usvtufe !lfzt!jo!uifjs!OUQ!qpmjoh!qbdlfut!xjmm  
sfdjwf!bvuijoujdbufe!sfqmjft!gspn!uif!Tpopnb`E23/!!Xifo!zpv!ibwf!foufsfe  
bmm!pg!uif! usvtufe!lfzt !uibu!zpv!offe-!foufs!{fsp!bu!uif!ofyu!qspnqu!gps!b  
lfz!ovncfs/

Foufs!b!usvtufe!lfz!ovncfs!)2.76645\*!ps!1!up!rvju;!!2

Foufs!b!usvtufe!lfz!ovncfs!)2.76645\*!ps!1!up!rvju;!!3

Foufs!b!usvtufe!lfz!ovncfs!)2.76645\*!ps!1!up!rvju;!!1

...OUQ!Cspbedbtu0Nvmujdbtu!Dpogjhvsbujpo

Xpvme!zpv!mjlf!up!fobcmf!cspbedbtu0nvmujdbtu!tfswfs!pqfsbujpo@!)\z^ft-!\o^p\*!!z

Tfu!uif!ofuxpsl!cspbedbtu0nvmujdbtu!beesftt!gps!uif!Tpopnb`E23  
up!vtf/!!Gps!cspbedbtu!npef!po!JQW5!ofuxpslt-!uijt!beesftt!jt  
uif!bmm!2 t!beesftt!po!uif!tvc.ofu/

Fybnqmf;!222/223/224/366

Po!JQW7!ofuxpslt-!uifsf!jt!npsf!uibo!pof!xbz!up  
efgjof!b!sbohf!pg!nvmujdbtu!beesfttft;

Fybnqmf;!gg16;;2!)bmm!opeft!po!uif!mpdbm!tjuf\*  
Fybnqmf;!gg13;;2!)bmm!opeft!po!uif!mpdbm!mjol\*

Uifsf!bsf!tqfdjgjd!nvmujdbtu!beesfttft!bttjhofe!gps!OUQ!Pqfsbujpo;

Gps!JQW5!nvmujdbtu!pqfsbujpo-!ju!jt!uijt!tqfdjgjd!beesftt.?!335/1/2/2  
Gps!JQW7!nvmujdbtu!pqfsbujpo-!ju!jt!uijt!tqfdjgjd!tjuf!tdpqf!beesftt.?!gg16;;212

Foufs!JQ!beesftt!gps!OUQ!cspbedbtu0nvmujdbtu!pqfsbujpo  
)bbb/cc/ddd/eee!ps!bbbb;;cccc!\*;!!335/1/2/2

Zpv!ibwf!tfmfdufe!nvmujdbtu!pqfsbujpo/!!Foufs!uif!UUM!wbmvf!uibu!jt  
offefe!gps!nvmujdbtu!qbdlfut!po!zpv!ofuxpsl!)2-!43-!75-!7-!239-!271-!2:3-!335\*;!43

Ju!jt!ijhimz!sfdpnnfoefe!uibu!bvuijoujdbujpo!cf!vtfe!jg!zpv!bsf!vtjoh!OUQ  
jo!cspbedbtu0nvmujdbtu!npef/!!Puijsxjtf!dmjfout!nbz!fbtjnz!cf! tqppgfe !cz  
b!gblf!OUQ!tfswfs/!!Zpv!dbo!tqfdjgz!bo!NE6!lfz!ovncfs!uibu!uif!Tpopnb`E23  
xjmm!vtf!jo!jut!cspbedbtu0nvmujdbtu!qbdlfut/!!Uif!dmjfout!po!zpv!ofuxpsl!nvtu  
cf!dpogjhvsfe!up!vtf!uif!tbnf!lfz/

Xpvmelzpv!mjlf!up!tqfdjgz!bo!NE6!lfz!ovncfs!up!vtf!xjui  
cspbedbtu0nvmujdbtu!npef@!) \z^ft-! \o^p\*!!z

Foufs!uif!NE6!lfz!ovncfs!up!vtf!) 2.76645\*;!!3

+++++  
+++++  
+!!+  
+!!Uif!Tpopnb`E23!Ofuxpsl!Ujnf!Qspupdpm!dpogjhvsbu jpo!ibt!cffo!vqebufe/!!!!!!!!+  
+!!+  
+!!!!!!!!!!!!!!!!!!Qmfbtfsf.cppu!opx!gps!uif!dibohft!up!ublf!fggfdu/!!!!!!!!!!!!!!!!!!!!!!!!+  
+!!+  
+++++  
+++++  
+++++

!  
!!  
Configuring the Sonoma as a Stratum 2 Server

Qrgtcvki "Uppq o c"cu"Uvtcvw o "3"Ugtxgt"ku"vjg"tgeq o o gpfgf" o qfg0" J qy xgt."vjgtg"ctg/vk o gu"y jgp"  
Uvtcvw o "4"qrgtcvki"ku"i qqf"uvtcvgi {<

" 30"Y jgp" {qw"y cpv" c"dcemwr"uqwtg"qh"vk o g0"Kp"vjku"ecug."Uppq o c"y knn"qrgtcvg"cu"Uvtcvw o "3"  
Ugtxgt"cu"nqi"cu"kv"ku"nqemgf"vq"vjg" I RU"uki pcn0"Kh"kv"nqugu"vjg"uki pcn."vjgp"Uppq o c"y knn"uvtcv"vq"ftkhv"  
cyc{ "htq o "drgthgev0"vk o g0" Gxgpwcn{."y jgp"kv"jcu"ftkhvf"32" o knnkugeqpfu."kv"tgej"vjg"wpnqemgf"eqp/  
fkvqp"cpf"uvqr"ugtxki"vk o g"qp" {qwt"pgvy qtm0"Kh" {qw"jcxg"Uppq o c"eqpLi wtgf"ht"Uvtcvw o "4"qrgtc/  
vkqp."vjgp"kv"y knn"eqpvkpwg"ugtxki"vk o g."wukpi"cpqvjgt"Vk o g"Ugtxgt"cu"kvu"tghgtpeg0"Kh"Uppq o c"ku"ncvgt"  
cdng"vq"ceswktg"nqem"qp"vjg" I RU"uki pcn"ci ckp."kv"y knn"u y kvej"dcem"vq"Uvtcvw o "3"qrgtcvki

" 40"Y jgp" {qw"y cpv" {qwt"Uppq o c"vq"ugtxg"ceewtcvg"vk o g."dwv" {qw"fqpp0"y cpv"vq"uwg"vjg"cpvgppc"ht"  
uq o g"tgcuqp+0"Kp"vjku"ecug."Uppq o c"ecp"qrgtcvg"uqngn{ "cu"Uvtcvw o "4"ugtxgt."y kvj"pq"cpvgppc"eqp/  
pgevfg0

Ukpeg"vjgtg"ctg"kpwo gtcndg"yc{u"vq"eqpLi wtg" {qwt"pgvy qtm"y kvj"Uvtcvw o "4"ugtxgtu."urgekLe"kpwtwe/  
vkqpu"ht"j qy"vq"fq"vjcv"ctg"dg{ qpf"vjg"ueqrg"qh"vjku" o cpwcn0" I gpgtcn"kpvtwevkqpu"qp"j qy"vq"gfkv"vjg"  
pvr0eqph"Ln g"ctg"dgnqy0

Edit ntp.conf File

[qw" o wuv"gfkv"vjg"pvr0eqph"Ln g"kp"qtfgt"vq"rqkp" {qwt"Uvtcvw o "4"ugtxgt"cv"Uvtcvw o "3"ugtxgt0"Gfkv"l gve/  
pvr0eqph"cpf"cff" {qwt"ugtxgt"nkp g\*u+0"\*Ugg" "ht"kpht o cvkqp"  
jtO

IMPORTANT

Pqy"ucxg"vjg"gfkgf"Lng"cpf"eqr{"kv"vq"vjg"pqp/xqncvknng"fcuj"rctvkvkqp"ykvj"vjku"eqo o c p f <

! dq! .q! 0fud0ouq/dpog! 0cppu0fud

Mask Alarm

Kp"Uvtcvw o "3"qrgtcvkqp"cp"cnct o "yknndg"kpfkcevgf" y jgp"vjgtg"ku"cnquu"qh"uki pcn"qt"kh"vjg"cpvgppc"ku"
pqv"eqppgevgf0"Hqt"Uvtcvw o "4"qrgtcvkqp" {qw" o c { "pqv" y cpv"vq"ugg"vjgug"cnct o u0" [qw"ecp" o cum"vjg o "
\*rtxgvp"vjg o "htq o "ujqykpi+"d{ "wukpi"vjg"eqpuqng" rqtv"\*ugtkcnpvgv y qtm+"eq o o c p f u" t f u t j h g m u n b t 1 "
cpf" t f u b o u g m u n b t 1 0 " Q t . " q p " v j g " h t q p v / r c p g n " m g { r c f l f k u r n c { " i q " v q " v j g " H c w n v u " u w d o g p w 0 " " N q q m " h q t "
UkiHnvOcum"cpf"CpvHnvOcum"cpf"ugv"vjg o "crrtrtkcvgn {0

Setting Up NTP Clients on Unix-like Platforms

Vq"eqpEiwtg" {qwt"Wpkz/nkmg"eqo rrwgt"vq"wug" {qwt"Uppq o c." {qw" o wuv"jcxg"uweeguuhwnn{ "eq o r n g v g f "
vjg"PVR"Ugtxgt"dcuke"kpucnncvkqp"rtqegfwtg"fguetkdgf"cdqxg0"Kv"ku"gzrgevgf"vjcv" {qw"ctg."qt"jcxg"
ceeguu"vq."c"ecrcdng"Wpkz!Nkpwz"u{uvgo"cf o kpkuvtcvqt"cpf"mpqy" o qtg"vjcp" c"nkvnng"cdqvw"kpucnncvp i "
fkuvtkdvwkqpu"htq o "uqwtg"eqfg0"Kpucnncvkqp" o wuv"dg"rgthqt o gf"d{ "c"wugt"ykvj"tqqv"rtkxknngf i gu"qp"vjg"
u{uvgo 0}

kh" {qw"jcxg"ceeguu"vq" c" wugpgv"pgyu"ugtxgt." o c p { " r t q d n g o u " o c { " d g " u q n x g f " d { " v j g " j g n r h w n " r g q r n g " y j j "
rctvkekrcvg"kp"vjg"Kpvgtpgv"pgyu" i tqwr" fgxqvgf"vq" PVR"cv"eqo r0rtqvqeqnu0vko g0pvr0

Vjtg" o gvjqfu"qh"wukpi"Uppq o c" ykvj" PVR"enkppvu"qp"Wpkz/nkmg"rncvhtq o u"yknndg"fguetkdgf<

Vjku"ku"vjg"uk o r n g u v . " c p f " y k n n " q r g t c v g " y k v j q w v " O F 7 " c w v j g p v k e c v k p 0 "



É" [qw"jcxg"kpucnngf"PVR"qp"{qwt'enkgpv"eq o rwwgtl)

É" [qw"jcxg"uweeguuhwnn{" rghqt o gf"vjg" "qp"{qwt'enkgpv"  
eq o rwwgtl)

Create the ntp.keys File

[qw" o wuv"etgcvg" c"Lnq"pc o gf"pvr0mgfu"kp"vjg"lgye" fktgevt {0""Kv" o wuv"dg" c"eqr {"qh"vjg"qpg"tgukfki"kp"  
vjg"lgye" fktgevt {"qh"{qwt"Uqpq o c0"" [qw"ecp"u**fmo**fu"kpq" {qwt"Uqpq o c"cpf"uvctv"cp"guq"uguukqp"ykvj"  
{qwt'enkgpv"eq o rwwgt"vq"ugpf"vjg"Uqpq o cø"





**tfswfs!2:3/279/2/231**

qt"vjg"cwvjgpkvcvgf"xgtukqp"cffgf"kp" <

**tfswfs!2:3/279/2/231!lfz!2**

Configure NTP Client for Multicast

[qw"o wuv"gfkv"vjg"pvrleqpl"Ln"y jkej"ouqe."vjg"PVR"fcg o qp."nqqmu"hqt"d{ "fghcwnv"kp"vjg"vjg"lgye" fktgevqt{0"Cpf"cff"vjgug"nkpgu"hqt"o wnvkecu<

**nvmujdbtudmjfou!335/1/2/2**

qt"hqt"KRx8<

**nvmujdbtudmjfou!gg16;;212**

kh"{qw"ctg"pqv"wukpi"OF7"cwvjgpkvcvkqp."{qw"y qwnf"cff"vjgug"nkpgu<

**ejtbcmf!bvui**

**nvmujdbtudmjfou!335/1/2/2**

qt"hqt"KRx8<

**ejtbcmf!bvui**

**nvmujdbtudmjfou!gg16;;212**

[qw"o c{"tgoqxg"vjg"nkpg"cffgf"rtgxkqwun{"kp"Wpkz/nkmg"Rncvht

"En

"Ugvwr



## Security

```
Hqt"Wpkz/nkmg"rncvhtq o u" {qw"ecp"eqpŁi wtg" {qwt"PVR"enkgpvu"ht"ugewtg"OF7"cwvjgpvkecvkqp0""Ugg"
0"" [qw"ecp"cnuq"tguvtkev"PVR"swgt {"ce/
eguu"/"ugg"dgnq y0
"
```

### Restrict NTP Query Access

```
Vjg"Pgv y qtm"Vk o g"Rtqvceqn"*PVR+"k o r ng o g pvcvkqp"kp"Uqpq o c"ku"dwknv"htq o "vjg"tghgtgpeg"fkuvtkdwwkqp"
c<
```

```
" pyvkog0qti lfqypnqcfu l
```

```
D {"hcevqt {"fghcwnv."tg o qvg"eqpvtqn"cpf" swgt {"qh"vjg"PVR"fcg o qp"ouqe"ku"fkucdngf0""Swgt {/qpn {"
qr gtcvkqp"ku"uw r rqtvgf"qp n {"htq o "rtqeguugu"twppkpi"qp"Uqpq o c"kvugnh."k0g0"htq o "vjg"nqecnjqv0""Vjku"
tguvtkevu"ceeguu"vq"ouqe"htq o "tg o qvg"jquvu"wukpi" gkvjgt"qh"vjg"v y q" PVR"eq o rcpkqp"vwknkvkgu"ouqr"cpf"
ouqed0
```

```
Eqpvtqn"xkc"vjgug"v y q"vwknkvkgu"ku"fkucdngf"kp"vjg"lgvelpvr0eqph"Łng"kp"v y q" y c {u0""Hktuv."OF7"cwvjgpvkec/
vkqp"mg {u"ctg"pq"fgŁpgf"ht"eqpvtqn"qr gtcvkqp"xkc" c"tgswguvmg"qt"eqpvtqmmg"fgencctcvkqp0""Ugeqpf."
vjku"fghcwnv"cfftguu"tguvtkevqp"nkp"ku"rtgugpv"kp"vjg"Łng<
```

```
sftusjdu!efgbvmu!opnpejgz!opr vfsz!opqffs
sftusjdu!238/1/1/2!opnpejgz
sftusjdu!1;;2!opnpejgz
```

```
Vjg"Łtuv"nkp"gnk o kpcvgu"eqpvtqn"cpf" swgt {"ceeguu"htq o "CNN"jquvu0""Vjg"ugeqpf"cpf"vjktf"nkp"fkucdng"
vjg"nqecnjqv"htq o " o cmkpi"cp {" o qfkŁecvkqpu"vq"vjg"ouqe"fcg o qp."dwv"swgt {"ceeguu"ku"pq"chhgevgf"
d {"vjku"tguvtkevqp0""Vjgug"nkp"gu" o wuv"pq"dg"tg o qxgf."cu"vjg {"ctg"pgeguuct {"ht"xctkqu" o qpkvqtqi"
rtqeguugu"twppkpi"qp"Uqpq o c"vq"hwpevkqp"rtgrgn {0
```

```
Mpqyngf icdng"PVR"wugtu" y j q" y qwnf"nkmg"vq"ewuvq o k |g"vjg"ugewtkv {"curgevu"qh"vjg"eqpŁi wtcvkqp"qh"
vjg"PVR"fcg o qp"kp"Uqpq o c"ujqwnf" gfkv"vjg"lgvelpvr0eqph"Łng"fktevn {"cpf"vjgp"eqr {"kv"vq"vjg"ldqqvlgeve"
fktgevt {0""Dg"uwtg"vq"tgvcv"vjg"qypgtujkr"cpf" rgt o kuukqpu"qh"vjg"qtk i kpcn"Łng"d {"wukpi"dq! q" y jgp"
rgthqt o kpi"vjg"eqr {0
```

**CAUTION**

If you are planning to make changes to the   file, you must NOT restrict query access from the local host to the NTP daemon. Various system monitoring processes running on the system require this access.

```
Cp"gzc o r ng"hqmq y u" y jke j"ujq y u"j q y"vq"cnny" swgt {"ceeguu"htq o "c"urgekŁe"tg o qvg"jqv" y kvj"KR"cf/
ftguu"3;4038:03032" y jkng"cnuq"cnny kpi"rtqeguugu"twppkpi"qp"Uqpq o c"vq"jcxg"swgt {"ceeguu"cu" y gmn<
```

```
sftusjdu!efgbvmu!opr vfsz!opnpejgz!opqffs
sftusjdu!238/1/1/2!opnpejgz
sftusjdu!1;;2!opnpejgz
sftusjdu!2:3/279/2/21!opnpejgz
```

Vjku"rcig"kpvgpvkqpcm{"nghv"dncpm0



## Two Gigabit Ports

```
Vjg"RVR"fcg o qp"uvcvwu"cpf"eqpŁi wtcvkqp"ku"uwr rqtvgf"htq o "vyq"RVR"eq o rcpkqp"wwknkvkgu"quqtubuy!
cpf"quqdpogjhy." y jgtg"z"ku"pgvy qtm"rqtv"2"*fui1*"qt"3"*fui2*0""Vjg"hqmqy kpi "vcdng"ujqy u"vjg"
Uqpq o c"wwknkvkgu"vjcv"rgtvckp"vq"RVR<"
```

RVR	quqe1 quqe2	quqtubu1 quqtubu2	quqdpogjh1 quqdpogjh2

```
RVR"ecp"dg"gpcdnfg"qp"qpg"qt"dqvj"pgvy qtm"rqtvu"*fui1"cpf"fui2+0""Kh"RVR"ku"gpcdnfg"qp"qpn{"qpg"
rqtv."vjgp"fui1"ku"vjg"pgvy qtm"rqtv"kf gpkŁgt"cpf" {qw"y qwnf"wug"quqtubu1"cpf"quqdpogjh1"htq"
RVR"uvcvwu"cpf"eqpŁi wtcvkqp0""Kh"RVR"ku"gpcdnfg"qp"dqvj"rqtvu."vjgp"dqvj"fui1"cpf"fui2"y knm"dg"wugf0
```

## PTP Configuration and Status

```
Vjg"fghcwnv"RVR"eqpŁi wtcvkqp"ugwkp i u"kp"vjg"Uqpq o c"ctg"ujqy p"dgnqy0""Kh" {qw"pggf"vq" o qfkh{"vjgug"
ugwkp i u"vjgp" {qw"y knm"pggf"vq"tgeqpŁi wtg"vjg"RVR"Uwdu{uvgo0"" [qw"o c{"rgthqt o"vjg"eqpŁi wtcvkqp"
htq o "gkvjgt"c"ufmofu"qt"tti
```

## PTP Configuration Using the Network or Serial Port

Vjg"quqdpoqjh1"qt"quqdpoqjh2"eq o o c p f"uvctvu"cp"kpvgtcexg"ujgnn"uetkrv"vjcv"yknn"cnqy" {qw"vq" eqpŁiwtg"vjg"RVR"Uwdu{uvgo"qh"vjg"Uqpq o c 0" [qw"yknn"dg"rtq o rvgf"vq"ugv"RVR"rtc o gygtu"cu"hn/ nqy u<

```
" GVJ"Rqtv<" " " 2"qt"3
" U{pe"kpvgtxcn"*Rgt"Ugeqpf+<" 3."4."6." : ."38."54."86."34:
" Cppqwpeg"kpvgtxcn"*Ugeqpfu+<" 3."4."6." : ."qt"38"
" Rtkqtkv{3<" " " 2/477
" Rtkqtkv{4<" " " 2/477
" Fgnc{"Ogejcpku o <" "" " G4G"qt"R4R
" Fq o ckp<" " " 2/477
" RVR"Vko g"Oqfg<" " " WVE"qt"RVR
" RVR"VVN<" " " 3/477
" Vtcpu o kuukqp"Oqfg<" " " Owvkecu"qt" J {dtkf
```

Qpg"Łng"ku" o qfkŁgf"hqt"gej" rqtv 0" Gkvjgtlgvelrvr20eqph"hqt" fui1"qt"lgvelrvr30eqph"hqt" fui2 0" Vjgug" ctg"ppq/xqncvkng"Łngu"uvqtgf"kp"vjg"HNCUJ"fkum"ldqqvlgve" fktgevt{0" [qw" o wuv"tgdqqv"vjg"Uqpq o c" chvgt" twppki"vjku"uetkrv"hqt"vjg"ejcpi gu"vq"vcmg"ghhgev 0

Vjg"hnqnykpi"ku" c"vtcpuetkrv"qh"vjg"swguvqp"cpf"cpu ygt"eqpŁiwtcvkqp"wkknv{"rtqkkfgf"d{"quqdpo. gjh1!ps!quqdpoqjh2 0" Vjg"wugt/gpvgtgf"rtc o gygtu"ctg"ujqyp"kp" c"nctigt" hqp v 0

```

...QUQ!Qsjpsjuz3!Dpogjhvsbujpo
Tfu!uif!QUQ!Qsjpsjuz3!wbmvf!)1.366*!239

...QUQ!Efmbz!Nfdibojtn!F3F!ps!Q3Q
Tfu!uif!QUQ!Efmbz!Nfdibojtn!)F3F!ps!Q3Q*!Q3Q

...QUQ!Epnbj!Dpogjhvsbujpo
Tfu!uif!QUQ!Epnbj!wbmvf!)1.366*!1

...QUQ!Ujnf!Npef!Dpogjhvsbujpo
Tfu!uif!QUQ!Ujnf!Npef!)VUD!ps!QUQ*!QUQ

...QUQ!UUM!Dpogjhvsbujpo
Tfu!uif!QUQ!UUM!wbmvf!)2.366*!2

Tfu!uif!QUQ!Usbotnjttjpo!Npef!)Nvmujdbtu!ps!Izcsje*!Nvmujdbtu

```

```

+++++
+++++
+!!!!!!!!!!!!!!!!!!!!!!!!!!!!!!!!!!!!!!!!!!!!!!!!!!!!!!!!!!!!!!!!!!!!!!!!!!!!+
+!!Uif!Qsfdjtjpo!Ujnf!Qspupdpm!JFFF.2699!W3!dpogjhvsbujpo!ibt!cffo!vqebufe/!!!!+
+!!!!!!!!!!!!!!!!!!!!!!!!!!!!!!!!!!!!!!!!!!!!!!!!!!!!!!!!!!!!!!!!!!!!!!!!!!!!+
+!!!!!!!!!!!!!!!!!!Qmfbtf!sf.cppu!opx!gps!uif!dibohft!up!ublf!fggfdu/!!!!!!!!!!!!+
+!!!!!!!!!!!!!!!!!!!!!!!!!!!!!!!!!!!!!!!!!!!!!!!!!!!!!!!!!!!!!!!!!!!!!!!!!!!!+
+++++
+++++

```

Pqy"tgdaqv"vjg"u{uvg o "d{"kuwkpi "vjku"eq o o cpf"cv"vjg"ujgmn"rtq o rv<  
 sfcppu

### PTP Status Using the Network or Serial Port

Vjg"quqtubu1"qt"quqtubu2"eq o o cpf"cmqyu" {qw"vq"swgt {"vjg"uvcvwu"qh"vjg"RVR"Uwdu {uvg o 0"Hqn/  
 nqy kpi "ku"vjg"tgurqpug"vq"vjku"eq o o cpf<

W!!TJ!!BJ!!Q2!!Q3!!EN!!EPN!!NPEF!!UUM!!DMBT!!TDBMF!!TUBUF!!DMLJE!!VUD!VUDW!!DB!!M6!!M72!!UU!!GU!UN

Yjgtg<

- X" " ku"vjg"KGGG/37: : "xgtukqp"4"hqt"vjg"422: "uvcpfctf0
- UK" ku"vjg"RVR"u{pe"kpvgtxcn" "gkvjgt"3."314."316."31: ."3138."3154."3186."qt"3134: "ugeqpfu0
- CK" ku"vjg"RVR"cppqwpeg"kpvgtxcn."gkvjgt"3."4."6: : "qt"38"ugeqpfu0
- R3" ku"vjg"RVR"rtkqtkv {"3"kp"c"tcpig"htq o "2"vq"4770
- R4" ku"vjg"RVR"rtkqtkv {"4"kp"c"tcpig"htq o "2"vq"4770
- FO" ku"vjg"RVR"fnc {" o gejc pku o ". "gkvjgt"G4G"qt"R4R0









## UTC Time

```
Y jgp"vjg"RVR"Vko g"Oqfg"ku"ugv"vq"WVE."vjgp"vjgtg"ykm"dg"c"qpg"ugeqpf"lwo r"kp"vko g"y jgp"c"ngcr"
ugeqpf"kpugtvpq"qeewtu0""Kh"vjg"RVR"uncxg"fqgu"pqv"ceeqp"v"ht"vjku."kv"y km"cnuq"lwo r0""Cxqkf"vjku"d{
wukpi"RVR"Vko g"Oqfg0
```

## Multiport PTP

```
Y jgp"qpn{"qpg"RVR"qr vkqp"ku"gpdcngf"kv"y km"dg"eqpLi wtf"ht"fu1"RVR"fq o ckp"20""Kh"c"ugeqpf"RVR"
qr vkqp"ku"gpdcngf"vjgp"kv"y km"dg"eqpLi wtf"ht"fu2"RVR"fq o ckp"30""Vjku"eqpLi wtcvkqp"y km"cnngy"
RVR"vq"twp"cu"o cuvgt"qp"dqvj"rqtvu0
```

```
Kh"vjg"RVR"fq o ckp"ku"eqpLi wtf"cu"vjg"uc o g"xcnwg"ht"dqvj"rqtvu"*ht"gzco rng."RVR"fq o ckp"2"qp"
fu1"cpf"RVR"fq o ckp"2"qp"fu2+"vjgp"fu1"Rqtv"Uvcvg"y km"dg"o cuvgt"cpf"fu2"Rqtv"Uvcvg"y km"dg"
nkuvgpkpi0
```

Disable the  
PTP Protocol

```
Vjg"kpuvtwevkqpu"dgnqy"cuuw o g"vjcv"vjg"RVR"Qrvkqp"jcu"dggp"kpucnngf"qp"Rqtv"2"*fu1+"qh"{qwt"Uq/
pq o c0""Vq"ejgem."ugg"vjg"ugevkqp"vkvnfg" "cv"vjg"dgi kppkpi"qh"vjku"ejcrvt0
```

```
Vq"fkucdng"vjg"Rtgekukqp"Vko g"Rtqvqeqn"qp"Rqtv"2"kuuwg"vjg"hqmqy kpi"eq o o cpf<
```

```
! dinpe!.y!0fud0sd/e0sd/quqe1
```

```
EqR{"vjg"telrvrf2"Lng""vq"vjg"pqp/xqncvknng"HNCUJ"ctgc"nkmg"vjku<
```

```
! dq!.q!0fud0sd/e0sd/quqe1!0cppu0fud0sd/e
```

```
Vjgp<
```

```
! sfcppu
```

```
Qpeg"RVR"jcu"dggp"fkucdngf."vjg"wugt"kpvgthceg"y km"pq"nqpi gt"ujqy"vjg"gzkuvgpeg"qh"RVR0"
```

## Re-Enable PTP

```
Vq"tg/gpcdng"RVR"qp"Rqtv"2."tgo qxg"vjg"telrvrf2"Lng"htq o"vjg"lgvel telf"fkgtvqt{"cu"ujqyp"dgnqy<
```

```
! sn!0cppu0fud0sd/e0sd/quqe1
```

```
Vjgp<
```

```
! sfcppu
```

## NOTE

If PTP is also installed on Port 1, then follow the instructions above using .



Fktgev"tqqv"nqikpu"ctg"qpn{"rgt o kwgf"qp"vjg"nqecn"TU/454"eqpuqng"qt"xkc"UUJ0

Vjg"ugewtg"eqr{"wvknkv{."tdq."gnk o kpcvgu"vjg"pggf"vq"wug"vjg"kpugewtg"HVR"rtqvqeqn"hqt"vtcpuhttkpi"  
rtqitc o "wrfcvgu"vq"vjg"Uppq o c0

VVR"ceeguu"hqt"u{uvgo " o qpkvqtkpi"qpn{."ku"cmqygf"qpn{"xkc"UUN."uq"rcuuyqtfu"cpf"uguukqp"fcvc"  
ctg"gpct{rvgf"qp"vjg"yktg0"Ceeguu"xkc"JVVRU"oc{"dg"tguvtkevgf"qt"eq o rngvgn{"fkucdngf0"Ugg"  
"cpf" "dgnqy0

UPOR"ceeguu"hqt"u{uvgo " o qpkvqtkpi"qpn{."ku"eqpLiwtcdng"vq"rtqxxkf"vjg"ugewtkv{"qh"vjg"ncvguv"xgt/  
ukqp"5"kpvgtpgv"uvpcfctf"y jkej"uwr rqtvu"dqvj"xkgy/dcugf"ceeguu"eqpvtqn"cpf"wugt/dcugf"ugewtkv{"wukpi"  
o qfgtp"gpct{rvkqp"vgejpkswgu0"Rtgxkqwu"xgtukqpu"x3"cpf"x4e"uwr rqtvgf"ceeguu"eqpvtqn"guugpvkcm{"  
xkc"rcuuyqtfu"vtcpu o kwgf"qxgt"vjg"pgvy qtm"kp"rnckp"vgzv0"TGhgt"vq" cpf  
\*dgnqy+"hqt"fgvcknu0"UPOR"oc{"cnuq"dg"eq o rngvgn{"fkucdngf0"Ugg"  
"dgnqy0

Kpfxkfwcn"jqv"ceeguu"vq"rtqvqeqn"ugtxgt"fcg o qpu"jo/ufmofue-"tonqe"qt"ttie"ctg"eqpvtqngf"d{"  
fktgevxxgu"eqpvckpgf"kp"vjg"Lngu"lgveljqvuv0cmnqy"cpf"lgveljqvuv0fgpf. ! y jkej"ctg"eqpLiwtgf"wukpi"vjg"  
kpvgtcevxxg"uetkrv!bddfttdpogjh/!Ugg" "dgnqy0

Kpugewtg"rtqvqeqnu"nkmg"Vkog."Fc{vko g"cpf"Vgnpgv"oc{"dg"eq o rngvgn{"fkucdngf"d{"eqpLiwtcvkqp"qh"  
vjg"jofue"uwr gt/ugtxgt"fcg o qp"wukpi"vjg"kpvgtcevxxg"uetkrv"gp



Restrict Query Access - NTP

Vjg"Pgyqtm"Vkog"RtF c"Wu J







Ujqwnf" {qw"pggf"vq"tgrnceg" {qwt"mg{u"cv"cp{ "vk"og." {qw"ecp"lwuv"tg"ogxg"vjg"mg{u"htq"o"vjg"ldqqvlgvel  
uu.j" fktgevqt{ "cpf"vjgp"tgdqqv"vjg"Uppq"oc"l"C"pgy"ugv"qh"j"quv"mg{u"y"knncwvq"ocvkecnn{ "dg"i"gpgtcvgf0

Vq"eqpLi wtg"tqqv"nq"ikpu"vq" {qwt"Uppq"oc"xkc"rcuu"yqtfnguu."rwdnke"mg{ "cwvjgppvkecvkqp." {qw"o"uw"i"gp/  
gtcvg"c"rwdnkelr"tkxcvg"rckt"qh"UUJ4"mg{u"wukpi" {qwt"qyp"uu"j"mg{ "i"gpgtcvkpi" wvknkv{."qt" {qw"ecp" wug"vjg"  
tti. l fzhfo"vjcv"ku"tgukfgpv"qp"vjg"Uppq"oc"Lng"u{uvgo"l" [qw"o"uw"vjgp"cr"rgpf"vjg"rwdnke"mg{ "vq"vjg"  
ldqqvltqqvltuu"jlcwvjqtk/gfamgfu"Lng"kp"vjg"ppq/xqncvknq"HNCUJ"ctgc"qp" {qwt"Uppq"oc"l"Cv"dqqv"vk"og."  
vjg"Uppq"oc"y"knneqr{ "vjgug"vq"vjg"cevwn"y"qtmkp"i"ltqqvltuu"j" fktgevqt{ "qh"vjg"u{uvgo"tc"o"fkum"l"Vq" wug"  
vjku"ecrcdknkv{."vjg"eqttgurqpfkpi" rtkxcvg"mg{ "o"uw"tgukfg"kp"vjg"ltqqvltuu"j" fktgevqt{ "qh" {qwt"tg"ogvq"  
eq"orwvgt"cu"kfatic"qt"kfatic"l"Kh" {qw"ctg"wphe"oknct"y"kvj"vjku"rtqegu."tghgt"vq"vjg"o"cp"rcig"hqt"vjg"  
tti. l fzhfo" wvknkv{ "hqt"fgvcknu"kuuwg"nbo!tti. l fzhfo"cv"vjg"rtq"orv+l"v" \*Dg"ectghwn"vq"o"ckpvckp"vjg"  
rtqrgt"qypgtujkr"cpf"ceeguu"rgt"o"kuukqpu"qh"vjg"rtkxcvg"mg{ "d{ "wukpi"dq! .q! y"jgp"eqr{ kpi"vjg"Lng"l"  
kv"OWUV"dg"tgcfcng"qpn{ "d{ "tqqv"l"

Cfxcpegf" wugtu"y"ku"j"kpi"vq"o"qfkh{ "vjg"qxgtcnn"eqpLi wtcvkqp"qh"vjg"tti"e"fcg"o"qp"ujqwnf"gfkv"vjg"  
lgveluu"j"luuj"faeqphki"Lng"cpf"vjgp"eqr{ "kv"vq"vjg"ldqqvlgveluu"j" fktgevqt{ "qh"vjg"Uppq"oc"l" "Dg"ectghwn"vq"  
o"ckpvckp"vjg"rtqrgt"qypgtujkr"cpf"ceeguu"rgt"o"kuukqpu"d{ "wukpi"dq! .q" y"jgp"eqr{ kpi"vjg"Lng"l" "Cv"  
dqqv"vk"og."kv"y"knndg"eqrkgf"vq"vjg"lgveluu"j" fktgevqt{ "qh"vjg"u{uvgo"tc"o"fkum."vjgtgd{ "tgrncekpi"vjg"hce/  
vqt{ "fghcwnv"eqpLi wtcvkqp"Lng"l

"

HTTPS

Vjg"JVVRU"ugtxgt"kp"vjg"Uppq"oc"ku"dwknv"htq"o"vjg"uvcpfctf"Crccejg"xgtukqp"406032"fkuvtkdwwkqp"htq"o<

"" jwrf0crcejg0qti"

Kv" wugu"JVVRU" \*JVVR"qxgt"UUN+"y"kvj"o"qfaun"vjg"Crccejg"kpvgthceg"vq"QrgpUUN+l" Hqt"o"qtg"kphqt/  
o"cvkqp"cdqvv"vjku"rtqvqeqn."tghgt"vq<

" oqfuun0qti

PQVG<"Vq"fkucdng"vjg"JVVRU"rtqvqeqn"ugg" "cdqxg0"Vq"tguvkev"ce/  
eguu"ugg" "cdqxg0

JVVR"cpf"UUN" wug"Lngu"ht"vjg" fghcwnv"eqpLi wtcvkqp"nqecvfgf"kp"lgveljwvrf"l"Qh"vjgug." {qw"y"knncwv{rk/

de!0cppu0fud0iuuqe

pqfottm!sfr!.ofx!.y61:!.opeft!.pvu!tfswws/dsu!.lfzpvu!tfswws/lfz

Vjg"vyq"Łngu"ykm"dg"etgcvgf"kp"vjg"ldqqvlgveljvrrf"fktgevqt{0"" [qw"owuv"tgdqqv"vjg"Uppqoc"hqt"vjgo"  
vq"vcmg"ghhgev0""Cp"gzegmnpv"dqqm"yjkj"fguetkdgu"qrgtcvkqp"cpf"eqpŁiwtcvkqp"qh"vjg"xctkqwu"JVVRU"  
fktgevkgu"cpf"UUN"eqpŁiwtcvkqp"ku<

" Rtqhgukqpcn"Crcejg."Yckpytkijv."Ytqz"Rtguu."3;;;0"

NTP

[qw"ecp"eqpŁiwgt">{qwt"PVR"enkpvu"hqt"ugewtg"OF7"cwvjgpkcvkqp0""Ugg"

"qt"

0"" [qw"ecp"cnuq"tguvtkev"PVR"swgt{"ceegu0""Ugg"

kp"vjku"ejcrvgt0

Network Security  
Vulnerabilities

GpfTwp"cf ftguugu"oclt"pgvyqtm"ugewtkv{"xwnpgtcdknkvkgu"vjcv"chhgev"Uppqoc"cv"vjg"vqr"qh"vjku"ygd/  
rcig<

" gpfwtpvgejppqiqkgu0eqohlud0jvo

Vjku"Cr rnkecvkqp"Pqvg"fguetkdgu"dguv"rtcevkegu"vq"ugewtg">{qwt"vkog"ugtugt"cpf"okkicvg"ocp{"pgvyqtm"  
ugewtkv{"xwnpgtcdknkvkgu<

" gpfwtpvgejppqiqkgu0eqolrfhlCrrPqvgUgewtkv{0rfh



Enterprise Management  
Information Base (MIB)

kp"cf fkvkqp"vq"rtqxfkpi"vjg"UPOR"xctkcdngu"eqpvckpgf"kp"OKD/KK"cu"fguetkdgf"kp"THE/3435."GpfTwp"  
Vgejpqni kgu"jcu"ko r ng o gpvf"cp"gpvgrtkug"OKD"wukpi"vjg"u{pvcz"qh"vjg"UOK"xgtukqp"4"\*UOKx4+"cu"



After editing \_\_\_\_\_, you must copy it to the \_\_\_\_\_ directory and reboot the system. It is very important to retain the access mode for the file (readable only by \_\_\_\_\_), so be sure to use `chmod 400 _____`.

"

h"{qw"czg" [n"rtkpi"vq"wuh"





<u>Hkgnf%</u>	<u>Hkgnf" P c o g"</u>	"	<u>Hkgnf" Xcnwg</u>
3"	wu o Wugt"	"	wu o Wugt
4"	wu o Uvcwu"	"	]c"pw o dgt"* o quv"nkmg{"3+_
5"	wugtUvqtc i gV{ r g"	"	]c"pw o dgt"* o quv"nkmg{"5+_
6"	gpi kpgkF"	"	]2z"hqnnq y g f"d{ "c"pw o dgt"uvtkpi l j cu j_
7"	pc o g" "	"	]2z"hqnnq y g f"d{ "c"pw o dgt"uvtkpi l j cu j_
8"	ugePc o g"	"	]2z"hqnnq y g f"d{ "c"pw o dgt"uvtkpi l j cu j_
9"	enqpgHtq o "	"	]PWNN."wpnguu"wugt" y cu"etgcvgf"htq o "c"enqpg_
:	cwvjRtqvqeqn"	"	]c"fqwgf"pw o dgt"tgrtgugpvkpi <"OF7."UJC."õõ_
;	cwvjMg{ "	"	]2z"hqnnq y g f"d{ "c"pw o dgt"uvtkpi l j cu j_
32"	rtkxRtqvqeqn"	"	]c"fqwgf"pw o dgt"tgrtgugpvkpi <"FGU."CGU."õõ_
33"	rtkxMg{ "	"	]2z"hqnnq y g f"d{ "c"pw o dgt"uvtkpi l j cu j_
34"	wugtRwdnkeUvtkpi "	"	]2z"hqnnq y g f"d{ "c"pw o dgt"uvtkpi l j cu j_

tonqusbaq"tgswktgu"\*fgrgpfkpi "qp"vjg"ngxgn"qh"ugewtkv{ "+"vjg"wug"qh"Łgnfu"6."7." : . ; ."32."cpf"330"" [ qwt" UPOR" o cpc i g o gpv"uvcvkqp\*u+" y knn"pggf"vq"dg"eqpŁiwtgf"vq" j c p f n g " v j g u g " j c u j g f " x c n w g u 0

Cf fkvkqpcnn{."kp"lgvelupo rvtcruleqph" {qw" y knn"pggf"vq"ejcpi g"vjg"ugvvpki "hqt"X5"vq"QP0""Eqr { " upo rvtcruleqph"vq"ldqqvlgvel"chvgt" {qw" jcxg" o c f g " v j q u g " e j c p i g u " u q " u g v v k p i u " y k n n " d g " u c x g f " v j t q w i j " tgdqqvu" y kvj "er"/c"upo rvtcruleqph"ldqqvlgvelupo rvtcruleqph0

[qw"ujqwnf"ngcxg"X3X4E"ugv"vq"QP"wpvkn" {qw"xgtkh{ "vjcv" {qw"ecp"tgegkxg"UPORx5"pqvkŁecvkqulpk/ hqt o u 0 "" V j g p " { q w " e c p " e j c p i g " v j g " x c n w g " v q " Q H H 0

Example of usmUser Record

1			
[Redacted]			
9	10	11	12
authKey	privProtocol	p	
[Redacted]			

Vjg"ko c i g"cdqxs"ujqyu"cp"gzco r ng"qh"c"wu o Wugt"tgeqtf." y jgtg"vjg"Łgnfu"ctg<

<u>Hkgnf%</u>	<u>Gzc o r ng" Hkgnf" Xcnwg</u>
7" ( "8"	jcu j g f " h t q o " v j g " x c n w g " t q q v "
:	OF7
;" "	jcu j g f " h t q o " v j g " x c n w g " g p f t w p a 3
32"	FGU
33"	jcu j g f " h t q o " v j g " x c n w g " g p f t w p a 3

Disable or Restrict Access

Vq"flucdng"UPOR"ugg" 0""Vq"tgutkev"ceeguu"vq"  
 urgekŁe"jquvu"ugg" 0









`Fkurnc{"kpygpukv{"`





YIU/:6NcuvRqukvkqpHkz

Ncvkwfvg." " Vjgug"Łgnfu"ujqy"kpht o cvkqp"hqt"vjg" o quv"tgegpv"rqukvkqp"Łz0""Vjg"YIU/:6  
Nqpi kwfvg." " ncvkwfvg"cpf"nqpi kwfvg"kp"fgi tggg." o kpwvgu."ugeqpfu"hqt o cv"cpf"vjg"jgkijv"cdqyg"  
Jgkijv" " vjg"YIU/:6"tghgtgpeg"gnkruqkf"kp" o gvgtu"ku"ujqyp0""Tghgt"vq"  
0

IRU/WVE"Čn o cpce"Kphq

Vjgug"Łgnfu"ujqy"vjg"KEF/IRU/422"čn o cpce"rctc o gvgtu"y jkej"ctg"wugf"vq"tgncvg"IRU"vk o g"vq"WVE0"

NU."NUH" " Vjgug"Łgnfu"eqpvckp"vjg"ewttgpv"ngcr"ugeqpf"cpf"hwvwtg"ngcr"ugeqpf"xcnwgug0

Y PNUH."FP" Vjgug"Łgnfu"ujqy"vjg"IRU"yggm"pwo dgt"cpf"fc{"pwo dgt"qh"yggm"cv"vjg"gpf"qh"  
" " " " HO É X W X U H H F O G D L À p % ` 0 ` p @ À 0 p ° @ € δ % ! \$ L H

Vk o g" Fg xk c v k q p" " " " " " "	V j k u" L g n f" u j q y u" v j g" v k o g" f g x k c v k q p" * V F G X + " q h" v j g" q h h u g v" o g c u w t g o g p v u" k p" u g e q p f u 0" V j g" v c w" c u u q e k c v g f" y k v j" v j k u" o g c u w t g o g p v" k u" q p g" u g e q p f. " y j k e j" k u" v j g" w r f c v g" k p v g t x c n" q h" v j g" r q u k v k q p" L z g u" t g e g k x g f" h t q o" v j g" I R U" T g e g k x g t 0
Q u e k n n c v q t" " C i g k p i" T c v g"	V j k u" L g n f" u j q y u" v j g" t g i" t g u u k q p/ e q o r w v g f" u { u v g o" q u e k n n c v q t" c i g k p i" t c v g" r g t" f c { " * u g x g t c n/ j q w t u" f g n c { " d g h q t g" v j g" L t u v" o g c u w t g o g p v u" c t g" f k u r n c { g f + 0
E q p v t q n" N q q r" V C W" " " " " " "	V j k u" L g n f" u j q y u" v j g" u { u v g o" q u e k n n c v q t" e q p v t q n" n q q r" c x g t c i k p i" v k o g" e q p u v c p v. " k p u g e q p f u 0" K v o u" x c n w g" k u" c w v q o c v k e c m n { " c f l w u v g f" v q" o c k p v c k p" q r v k o w o" q h h u g v" c p f u v c d k n k v { 0
E q c u v" F w t c v k q p" " " " " " "	V j k u" u j q y u" v j g" p w o d g t" q h" u g e q p f u" v j g" I R U" U w d u { u v g o" j c u" d g g p" k p" e q c u v" o q f g. y j k n g" v j g" U q p q o c" k u" w p n q e m g f" v q" I R U 0" " E q c u v" o q f g" k u" c p q v j g t" v g t o" h q t" j q n f q x g t o q f g 0
G u v k o c v g f" V k o g" G t t q t" "	V j k u" k u" v j g" g u v k o c v g f" v k o g" g t t q t" q h" v j g" I R U" U w d u { u v g o" y j g p" k p" e q c u v l j q n f q x g t o q f g. " k p" u g e q p f u 0
K p v g t p c n" E j c u u k u" V g o r g t c v w t g"	K p v g t p c n" e j c u u k u" v g o r g t c v w t g" k p" A E 0" " C x c k n c d n g" y k v j" Q E Z Q" q t" T w d k f k w o q u e k n n c v q t u 0

Clock Page

V j k u" r c i g" u j q y u" v j g" e q p L i w t c v k q p" q h" v j g" U q p q o c" V k o g" U g t x g t" g z e g r v" h q t" c p { " q r v k q p c n" K l Q" y j k e j" k u" n k u v g f" q p" v j g" K l Q" r c i g 0" "

E n q e m" E q p L i w t c v k q p

Vk o g" O q f g" " " " " " " " " " " " " " " "	V j k u" L g n f" u j q y u" v j g" e w t t g p v" v k o g" o q f g" u g v k p i 0" " R q u u k d n g" u g v k p i u" c t g" W V E. " I R U" c p f" N q e c n 0" " U k p e g" P V R" c n y c { u" w u g u" W V E. " v j k u" u g v k p i" q p n { " c h h g e v u" v j g" h t q p v/ r c p g n" f k u r n c { " c p f" c p { " q r v k q p c n" V k o g" E q f g" q t" U g t k c n" V k o g" q w v r w v u 0" " H q t" g z c o r n g. " k h" v j k u" L g n f" u j q y u" N q e c n. " v j g p" v j g" v k o g" u j q y p" q p" v j g" h t q p v/ r c p g n" f k u r n c { " y k n n" d g" N q e c n" v k o g" d w v" P V R" y k n n" t g o c k p" c v" W V E" v k o g 0" " V q" e j c p i g" v j g" v k o g" o q f g" u g v k p i w u g" v j g" t z t u j n f n p e f d p o g j h" e q o o c p f" x k c" v j g" e q p u q n g" r q t v 0
Vk o g" \ q p g" " Q h h u g v" " " " "	V j k u" L g n f" u j q y u" v j g" q h h u g v" h t q o" W V E" c p f" k u" q p n { " x c n k f" y j g p" v j g" V k o g" O q f g" k u" N q e c n 0" " C" r q u k v k x g" V k o g" \ q p g" Q h h u g v" k o r n k g u" c" n q p i k v w f g" g c u v" q h" v j g" I t g g p y k e j o g t k f k c p 0" " V q" e j c p i g" v j g" v k o g"   q p g" w u g" v j g" t z t u j n f n p e f d p o g j h" e q o o c p f 0
F c { n k i j v" U c x k p i u" V k o g" "	V j k u" L g n f" y k n n" u j q y" y j g v j g t" F U V" e q p v t q n" k u" g p c d n g f" q t" p q v 0" F U V" L g n f u" c t g" q p n { " w u g f" y j g p" v j g" V k o g" O q f g" k u" N q e c n 0
F U V" U v c t v. " " F U V" G p f" " " " " " " " " " " " " "	V j g u g" L g n f u" y k n n" q p n { " f k u r n c { " k h" v j g" F c { n k i j v" U c x k p i u" V k o g" L g n f" c d q x g" u j q y u g p c d n g f 0" " K h" g p c d n g f. " v j g p" v j g u g" L g n f u" u j q y" y j g p" F U V" u v c t v u" c p f" g p f u" f w t k p i" v j g { g c t 0" " H q t" g z c o r n g. " k p" o q u v" q h" v j g" W 0 U 0 C 0" v j g" F U V" U v c t v" V k o g" k u" v j g" 4 p f" U w p f c { k p" O c t e j" c v" 4" c 0 o 0" " V j g" F U V" G p f" V k o g" k u" v j g" 3 u v" U w p f c { " k p" P q x g o d g t" c v" 4 c 0 o 0" " F U V" u g v k p i u" c t g" w u g f" y j g p" v j g" v k o g" o q f g" k u" N q e c n 0" " V q" e j c p i g" v j g" F U V u g v k p i u" w u g" v j g" t z t u j n f n p e f d p o g j h" e q o o c p f 0



Network: IPv6 Page

Vjku"rcig"ujqyu"kphqt o cvkqp"tgncvgf"vq"vjg"KRx8"pgv y qtm"rctc o gvgtu0""Hqt" o qtg"kphqt o cvkqp"qp"KRx8"  
ugg" 0

Network: DNS Page

Vjku"rcig"ujqyu"vjg"KR"cf ftguugu"qh"vjg"rtk o ct{"cpf"ugeqpfct{"fq o ckp"pc o g"ugtxgtu0

Network: MAC Address Page

Vjku"rcig"ujqyu"vjg"ogfk/ceeguu/eqpvtqn"\*OCE+"cf ftguu"hqt"dqv j"Gvjgtpgv"rqtvu"\*fui1"cpf" fui2+0

NTP Page

Vjg"PVR"Uvcvwu"rcig"ujqyu"cn"kphqt o cvkqp"tgncvgf"vq"PVR"qrgtcvkqp0"

PVR"Uvcvwu

Uvcvwu" " Vjg"uvtcvw o "Lgnf"jcu"ugxgtcn"rquukdng"xcnwgu<  
" " " Uvtcvw o "3<" Vjg"ugtxgt"ku"hwmm{"u{pej tqpk | gf"cpf"ceewtcvg0

Firmware: Firmware Status Page

Vjg"Łto yctg"Uvcvwu"rcig"ujqyu"rctv"pw o dgtu"cpf"tgxkukqpu"hqt"Uqppq o c"Łto yctg

Hkto yctg"Uvcvwu

Nkpwz"THU"RP." Vjgug"Łgnfu"ujqy"vjg"Nkpwz"tqqv"Łng"u{uvg o "rctv"pw o dgt."xgtukqp" ("fcvg)  
Nkpwz"THU"Xgtukqp

Nkpwz"Mgtpgn"RP." Vjgug"Łgnfu"ujqy"vjg"Nkpwz"mgtpgn"rctv"pw o dgt."xgtukqp" ("fcvg)  
Nkpwz"Mgtpgn"Xgtukqp

IRU"Uwdu{uvg o " Vjku"Łgnf"ujqyu"vjg"IRU"Uwdu{uvg o "Łto yctg"xgtukqp)  
Hkto yctg

IRU"Uwdu{uvg o " Vjku"Łgnf"ujqyu"vjg"IRU"Uwdu{uvg o "Hkgnf"Rtqi tco o cndng" I cvg" Cttc { " \*HR I C+  
HR I C" " xgtukqp

Firmware: Linux RFS Upgrade Page

Vjku"rcig"ku"wugf"hqt"wr itc fkp i"vjg"Nkpwz"THU"Łto yctg" [qw" o wuv"dg"nqi igf"kp"cu"đtqqvđ"kp"qtfgt"vq"  
jcxg"ceeguu"vq"vjku"rcig"Vjg"ncvguv"tgngcugf"xgtukqpu"qh"Uqppq o c"Łto yctg"ctg"htggn{"cxckncdng"qp"vjg"  
GpfTwp"Vgejppnqikgu"ygduky" Hqt"fgvckngf"kpht o cvkqp"qp"jqy"vq"rgthqt o "vjg"wr itc f"gvjgt"xkc"vjg"  
pgvyqtm"rqtv."vjg"ugtkcn"rqtv."qt"vjg"JVVRU"kpvgthceg"ugg" 0"

Firmware: Linux Kernel Upgrade

Vjku"rcig"ku"wugf"hqt"wr itc fkp i"vjg"Nkpwz"mgtpgn"Łto yctg" [qw" o wuv"dg"nqi igf"kp"cu"đtqqvđ"kp"qtfgt"  
vq"jcxg"ceeguu"vq"vjku"rcig"Vjg"ncvguv"tgngcugf"xgtukqpu"qh"Uqppq o c"Łto yctg"ctg"htggn{"cxckncdng"qp"  
vjg"GpfTwp"Vgejppnqikgu"ygduky" Hqt"fgvckngf"kpht o cvkqp"qp"jqy"vq"rgthqt o "vjg"wr itc f"gvjgt"xkc"  
vjg"pgvyqtm"rqtv."vjg"ugtkcn"rqtv."qt"vjg"JVVRU"kpvgthceg"ugg"  
0"

Firmware: GPS Subsystem Upgrade Page

Vjku"rcig"ku"wugf"hqt"wr itc fkp i"vjg"Łto yctg" [qw" o wuv"dg"nqi igf"kp"cu"đtqqvđ"kp"qtfgt"vq"jcxg"  
ceeguu"vq"vjgug"rcig"Vjg"ncvguv"tgngcugf"xgtukqpu"qh"Uqppq o c"Łto yctg"ctg"htggn{"cxckncdng"qp"vjg"  
GpfTwp"Vgejppnqikgu"ygduky" Hqt"fgvckngf"kpht o cvkqp"qp"jqy"vq"rgthqt o "vjg"wr itc f"gvjgt"xkc"vjg"  
pgvyqtm"rqtv."vjg"ugtkcn"rqtv."qt"vjg"JVVRU"kpvgthceg"ugg" 0"

Firmware: GPS Receiver Upgrade Page

Vjku"rcig"gzkuu"kp"wpkvu"ujkrrgf"chvgt"Ocl"4239"\*ykvj"vjg"GpfTwp"IRU" Tgegkxgt+0"Vjku"rcig"ku"wugf"  
hqt"wr itc fkp i"vjg"Łto yctg" [qw" o wuv"dg"nqi igf"kp"cu"đtqqvđ"kp"qtfgt"vq"jcxg"ceeguu"vq"vjgug"rcig"  
Vjg"ncvguv"tgngcugf"xgtukqpu"qh"Uqppq o c"Łto yctg"ctg"htggn{"cxckncdng"qp"vjg"GpfTwp"Vgejppnqikgu"  
ygduky" Hqt"fgvckngf"kpht o cvkqp"qp"jqy"vq"rgthqt o "vjg"wr itc f"gvjgt"xkc"vjg"pgvyqtm"rqtv."vjg"ug/  
tkcn"rqtv."qt"vjg"JVVRU"kpvgthceg"ugg" 0"

Firmware: Reboot Page

Vjku"rcig"ykm"cmqy" {qw"vq"rgthqt o "c"uqhvyctg"tgdqqv"qh"dqvj"vjg"Nkpwz"Uwdu{uvgo "cpf"vjg"IRU"  
Uwdu{uvgo0""Vjku"ku"pqt o cm{ "wugf"chvgt"c"Łt o yctg"wr itc fg"dww"ecp"dg"fqpg"cp{vkog" {qw"y kuj"vq"  
tgugv"vjg"Uqpqoc0

Disable or  
Restrict Access

Vq"fkucdng"JVVRU."ugg"  
urgekŁe"jquvu"ugg"

0

0""Vq"tguvtkev"ceeguu"vq"



NTP

D{"fghcwnv."ouqe"ku"hcevqt{/eqpŁiwtgf"vq"nkuvgp"qp"dqvj"KRx6"cpf"KRx8"cf f tguugu"qp"cnk"kpvgthcegu0""  
Vjku"oc{"dg"ejcpi g f" d{"gfkvkpi"l g v e l p v r 0 e q p h" c p f" c f f k p i" v j g" f g u k t g f" j o u f s g b d f" f k t g e v k x g u" v q"  
cejkxg"vjg"fguktgf"dgjcxkqt."cpf"vjgp"eqr {kpi"kv"vq"l d q q v l g v e 0""Hqt"gzco r ng."c f f k p i" v j k u" n k p g <

**joufsgbdf!jhopsf!jqw7**

ykmn"ecwug"pvr f"vq"pqv"dkpf"vq"cp{"KRx8"cf f tguugu0""Tghgt"vq"vjg"PV R" f q e w o g p v c v k p p" h q t" f g v c k n u" q p" v j g"  
**joufsgbdf**"fktgevkg0)

IPv4-Only Protocols

Vjgtg"ctg"ugxgtcn"rtqvceqnu"twppkpi"qp"vjg"Uqpqoc"y jkej"ctg"pqv"KRx8"ecrcdng<"ufmofu"\*enkpp"cpf"  
ugtxgt+."guq"cpf"eidqde0""Fwg"vq"vjgkt"kpvtkpuke"kpugewtkv{"ufmofu"cpf"guq"ctg"tcrkfn{"dgkpi"fg r t g /  
ecv g f." c p f" r t q d c d n {" j c x g" n k v v n g" d w u k p g u u" t w p p k p i" q x g t" c p" K R x 8" p g v y q t m 0"" V j g" c f f t g u u" c w v q e q p Ł i w t c v k q p"  
ecrcdknkvgu"qh"KRx8"cnqpi"ykvj"vjg"Pgki jdqt" Fkueqxt{"Rtqvceqn"\*PFR+"ocmg"vjg"FER"rtqvceqn"nguu"  
k o r q t v c p v" k p" K R x 8" p g v y q t m u 0"" V j g" q r v k q p c n" R V R l K G G G / 3 7 : : " r t q v c e q n" k u" c n u q" p q v" c x c k n c d n g" q p" K R x 8 0





Available User Commands

ceeguaeppŁi	kpygtcevkxg"uetkrv"vjcv"iwkfgu"{qw"kp"eqpŁiwtkpi" <b>ufmofu."tti"cpf"tonqe"ceeguu"vq"vjg"Uqpq o c"vjcv"ku"nk o kvgf"</b>



„pdt„ o dtg „



„sd o o ch t0



cpuio (Optional)

Ugg" "hqt"kphqt o cvkqp"qp"vjku"eq o o cpf0

cpuioconfig (Optional)

Ugg" "hqt"kphqt o cvkqp"qp"vjku"eq o o cpf0

cpustat

Vjku"eq o o cpf"ujqyu"ci tqwr"qh"mg{ "xcnwg"u"hqt" o qpkvqtkpi "vjg"jgc"nvj"qh"vjg"Nkpwz"ERW"cpf"qrgtcv/ kpi"u{uvgo "uvcvwu0""Vjg"hqt o cv"ku<

! ZZZZNNEE/II;NN;TT!MMM&!GSFF1C! ,UU/UD

Yjgtg<

[ [ [ [ " ku"vjg"{gct"qh"vjg"WVE"vk o guvc o r"qh"vjg"o quv"tgegpv"wr fcvg0

OOFF" ku"vjg"o qp"vj"cpf"fc{/qh/o qp"vj"qh"vjg"WVE"vk o guvc o r"qh"vjg"o quv"tgegpv"wr fcvg0

J J<OO<UU""ku"vjg"j qwt." o kpvvg"cpf"ugeqp"qh"vjg"WVE"vk o guvc o r"qh"vjg"o quv"tgegpv"wr fcvg0

NNN " " ku"vjg"rgtegpvc i g"qh" o czk o w o "nqcf"cu"tgwtpgf"wukpi "vjg"Nkpwz"wtubu"eq o o cpf0

HTGGmD" ku"vjg"cxckncdng"htgg" o g o qt { "kp"mknqd { vgu"cu"tgwtpgf"wukpi "vjg"Nkpwz"wtubu"eq o o cpf0

-VWVE" ku"vjg"vg o rgtcvwtg"kp"fgi tgg"egpki tcf"qh"vjg"Nkpwz"ERW"fk"vg o rgtcvwtg0

Eq o o cpf<" dqvutubu  
" Uppq o c"tgrn{<" 31281227/33;35;11!!34&!4311671C!! ,78/ :D

faultstat

Vjku"eq o o cpf"tgwtpu"vjg"uw o o ct { "qh"cmn"u { uvgo "hcwnv"uvcv"u"kp"c"wu"gt/htkppfn { "hqt o cv0""Kv" fgeqfgu"vjg" hcwnv"uvcvwu"y qtf"\*HNVU+"tgwtpgf"kp"vjg"hgttubu"eq o o cpf"cpf"fkurnc { u"vjg"tguwnv"kp"c"vcdwnc"t"hqt o " ykvj"xgtdqug"fguetkrvkqp0""\*Hqt"wpkvu"ujkrrgf"chvgt"Ocl"4239"vjgtg"ykn"dg"cf"fkvqpcn"hcwnvu"hqt"vjg" IRU" Tgegkxg0+""Hqt"fgvcknu"qp"vjg"xctkqwu"hcwnvu"ugg" 0

" Eq o o cpf<" gbvmutubu  
" Uppq o c"tgrn{<" Tztufn!Gbvmu!Tubvvt;  
! ! ! Tztufn!Ptdjmbups!EBD!.....?!PL  
! ! ! HQT!Tjhobm!.....?!PL  
! ! ! GQHB!Dpogjhvsbu jpo!.....?!PL  
! ! ! GMBTI!Xsjuft!.....?!PL  
!!! ! HQT!Sfdjwfs!Dpnnvojdbu jpo!.....?!PL  
!!! ! HQT!Sfgfsfodf!Ujnf!.....?!PL  
!!! ! Tvctztufn!Dpnnvojdbu jpo!.....?!PL  
!!! ! HQT!Boufoob!.....?!PL  
!!! ! Tztufn!Ptdjmbups!QMM!Vompdlfe.....?!PL  
!!! ! Tztufn!Qpxfs0Dpogjhvsbu jpo!.....?!PL















TEXFEPV"ku" c"eqwpv"qh"vjg"pw o dgt"qh" PVR"rcemgvu"tgegkxgf"ukpeg"uvctvwr"qh"vjg" PVR"fcg o qp0"  
 " " Vjku"ku" c"54/dkv"eqwpvgt"uq"kv" y kmn" y tcr"dcem"vq" |gtq"chvgt"6.4;6.;89.4;7"rcemgvu0  
 " "

UGPVEPV"ku" c"eqwpv"qh"vjg"pw o dgt"qh" PVR"rcemgvu"ugpv"ukpeg"uvctvwr"qh"vjg" PVR"fcg o qp0" "  
 " " Vjku"ku" c"54/dkv"eqwpvgt"uq"kv" y kmn" y tcr"dcem"vq" |gtq"chvgt"6.4;6.;89.4;7"rcemgvu0  
 " "

UGPVluge" ku"vjg"ewttgpv"tcvg"qh" PVR"rcemgvu"dgkpi"ugpv"rgt"ugeqpf0  
 " "

FTQREPV"ku" c"eqwpv"qh"vjg"pw o dgt"qh" PVR"rcemgvu"ftqr rrgf"ukpeg"uvctvwr"qh"vjg" PVR"fcg o qp0"  
 " " Vjku"ku" c"54/dkv"eqwpvgt"uq"kv" y kmn" y tcr"dcem"vq" |gtq"chvgt"6.4;6.;89.4;7"rcemgvu0  
 " "

Dgnqy"ku"cp"gzco rng"qh" c"v{ rkecn"tgurqpug"vq"vjku"eq o o cpf<

" Eq o o cpf<" ouqtubu  
 " Uppq o c"tgrn{<  
 " 31281228/11;13;51!.1/111111162!23:238:99!23:12618:!!26:5/50tfd!!!!!!26

oscctrlstat

Vjku"eq o o cpf"fkurnc{u"vjg"ewttgpv"xcnwgu"qh"vjg"u{uvgo"quekncvqt"eqpvtqn"rctc o gvgtu0"Vjgug"rctc o /  
 gvgtu"ctg"tgnvcgf"vq"vjg"fkuekrnkpgf"u{uvgo"quekncvqt0"Vjg"eq o o cpf"htq o cvu"vjg"fcvc"cpf"rtkpvu"vjku"  
 Łzgf/ngpivj"uvtkpi"jcxkpi"vjgug"Łgnfu<

! ZZZZNNEE/II;NN;TT!MLTUBU!DPBTU!FTUFSS!NFBTFSS!UJNFEFW!BHFSBUF!UBV!FGDEBD!UFNQ

Yjgtg<

[ [ [ [ " ku"vjg" {gct"qh"vjg"WVE"vk o guvc o r"qh"vjg" o quv"tgegpv"wr fcvg"tgegkxgf"htq o "vjg"  
 " " " IRU"Uwdu{uvgo0

O O F F " ku"vjg" o qp v j " c p f " f c { / q h / o q p v j " q h " v j g " W V E " v k o g u v c o r " q h " v j g " o q u v " t g e g p v " w r f c v g "  
 " " " t g e g k x g f " h t q o " v j g " I R U " U w d u { u v g o 0

J J < O O < U U " " ku"vjg"j qwt." o k p w v g " c p f " u g e q p f " q h " v j g " W V E " v k o g u v c o r " q h " v j g " o q u v " t g e g p v " w r f c v g "  
 " " " t g e g k x g f " h t q o " v j g " I R U " U w d u { u v g o 0

N M U V C V " " ku"vjg" IRU"Uwdu{uvgo"eqpvtqn"uvcvwu."gkvjgt"Y T O "\*y c t o k p i " w r + . "  
 " " " C E S " \* c e s w k t k p i + . " N M I " \* n q e m k p i + " q t " N M F " \* n q e m g f + 0

E Q C U V " " ku"vjg"pw o dgt"qh"ugeqpfu"vjg" IRU"Uwdu{uvgo"jcu"dggp"kp"eqcuv" o qfg"  
 " " " \*w p n q e m g f " v q " I R U + 0

G U V G T T " " ku"vjg"guvk o cvgf"vk o g"gttqt"qh"vjg" IRU"Uwdu{uvgo"y jgp"kp"eqcuv" o qfg."kp"  
 " " " u g e q p f u 0

O G C U G T T " " ku"vjg"ncuv" o gcuwtgf"vk o g"qhugv"qh"vjg" IRU"Uwdu{uvgo"vq" IRU"y jkng"nqemgf."kp"  
 " " " u g e q p f u 0



rcvrserialnumber

*Vjku"eqo o cpf"ku"pqv"cxckncdng"kp"wpkvu"ujkr rgf"dghqtg"Lwpg"42390*

## setantflmask

```
Vjku"eqo o cpf"cmnyu"{qw"vq"gpdcng"qt" o cum"vjg" IRU"cpvgppc"hcwnv0""Rctc o gvg"htq"vjku"eqo o cpf"ku"
gkvjgt"OCUMGF"qt"GPCDNGF0""Ugvykpi"vjku"eqo o cpf"vq"OCUMGF"yknn"rtgxp"vjg"cpvgppc"hcwnv"
htqo"etgcvkpi"cp"cncto"eqpfkvpq0""Uqog"kpucmncvkqpu"oc{"pggf"vq" o cum"vjku"hcwnv"fwg"vq"ur gekcn"
cpvgppc"ukvwcvkqpu"nkmg"urnkvgtu"qt"FE"dnqemu"vjcv"eqphwug"vjg"cpvgppc"fgvgevq"ektewk0""Vjg"hcevqt{"
fghcwnv"ugvykpi"ku"GPCDNGF0
```

```
" Eqo o cpf<"      tfubougmunbt1!NBTLFE
" Uppqoc"tgrn{<"  Boufoob!Gvmu!Nbt1!t fu!up!NBTLFE
```

## setcaldelay

```
Vjku"eqo o cpf"uvtvu"cp"kpvgtcevkxg"wwkknv{"vjcv"cmnyu"{qw"vq"ejcpig"vjg"enqem"ecndtcvkqp"fgnc{0""Vjku"
ugvykpi"ku"wugf"vq"cfxcpeg"qt"tgvtf"vjg"enqem"kp"qtfgt"vq"eqo rgpucvg"htq"cpvgppc"ecdng"ngpi"vj"qt"qvjgt"
gzvgtpcn"jctf yctg"qt"ecdnp i0""Cmnycdng"tcpig"ku"0722.222"pcpqugeqpfu0
```

```
" Eqo o cpf<"      tfudbme fmbz
" Uppqoc"tgrn{<"  Kpvgtcevkxg"wwkknv{"ku"uvtvgf0
```

## setgpsdynmode

```
Vjku"eqo o cpf"ceegrvu"cu"kp ing"ctiwo"gpv<""QP"qt"QHH"vq"cmnyu"{qw"vq"ugv"vjg"f{pc o ke" o qfg"qh"
qrgtcvkqp"qh"vjg" IRU"Uwdu{uvgo 0""D{"fghcwnv."vjg"wpkv"ku"eqpŁiwtgf"htq"uvcvke"qrgtcvkqp."uq"vjku"ugvykpi"
ku"QHH"Kk"vjg"Uppqoc"yknn"dg" o qwpvgf"qp"c" o qxkpi" rncvhtqo."nkmg"cu"jkr."vjgp"vjku"ugvykpi" o wuv"dg"
ejcpig"vq"QP0""Vjg"ejcpig"vcngu"rnceg"ko o gfkcvgn{"cpf"ku"uvqtgf"pqp/xqncvkngn{0
```

```
Kv"ku"ko rqtvcpv"vjcv"vjg"f{pc o ke" o qfg"dg"ugv"QHH" y jgp"vjg"kpvtwo"gpv"ku"kp"cu"uvcvke"kpucmncvkqpu"Vjku"
ku"vjg"hcevqt{/fghcwnv"ugvykpi0""Ugvy"vjg"f{pc o ke" o qfg"vq"QP"qpn{
```





```
" Eqo o cpf<"      tztptduzqf
" Uqqqoc"tgrn{<"  Jotubmmfe!Ptdjmmbups!jt!UDYP/
```

sysrootfs

```
Vjku"eqo o cpf"tgwvtpu"vjg"ewttgpn{"nqcfgf"Nkpwz"tqqv"Lng"u{uvgo."gkvjgt"2"qt"3."y jgtg"2"ku"vjg"hce/
vqt{/kpuvcmgf"tqqv"Lng"u{uvgo"cpf"3"ku"vjg"wr itcfgf"tqqv"Lng"u{uvgo
```

```
" Eqo o cpf<"      tztspugt
" Uqqqoc"tgrn{<"  CPPUFE!SPPU!GJMF!TZTUFN!JNBHF!>!2!)Vqhsbef*
```

sysstat

```
Vjku"eqo o cpf"cnnyu{"qw"vq"swgt{"vjg"uvcvwu"qh"vjg"PVR"Uwdu{uvgo"0"Kv"tgvtkgxgu"kphtq o cvkqp"htq o "
vjg"PVR"fcg o qp"vq"fgvgt o kpg"vjg"ewttgpn"u{pej tqpk|cvkqp"uvcvwu"qh"vjg"PVR"Uwdu{uvgo"0"Kv"vjgp"
tgvtkgxgu"vjg"ncuv"nkp"kp"vjg"nqi"Lng"lxtlnqilrtcgeku2lo qpkvqt"eqpvtqmgf"d{"vjg"PVR"fcg o qp"tghgtgpeg"
enqem"ftxgt"vjcv"eqo o wpkecvgu"ykvj"vjg"IRU"Uwdu{uvgo"0"Vjku"nqi"Lng"ku"wr fcvgf"gxgt{"38"ugeqpfu"
wpfgt"pqt o cn"qrgtcvkqp"0"Kv"rctugu"cpf"htq o cvu"vjg"fcvc"eqpvckpgf"vjg"tgp"cpf"rtkpvu"vjku"Łzgf/ngpi"vj"
*igpgtcnn{."ukpeg"i tqun{"wpu{pej tqpk|gf"uvcvgu"eqwnf"ecwug"vjg"Łqcvkpi"qhugv"Łgnf"vq"qxgt Łqy" o q/
ogpvtkn{+"uvtkpi"jcxkpi"vjgug"Łgnfu<
```

```
! MLTUBU!UP!HQT-!Pggtfu!>!,T/tttttttt-!MJ!>!@-!UGPN!>!@!A!ZFBS!EPZ!II;NN;TT!MT
```

Y jgtg<

```
NMUVCV" ku"vjg"u{uvgo"rggt"uvcvwu"qh"vjg"PVR"fcg o qp"tgnvcxg"vq"vjg"IRU"Uwdu{uvgo."gkvjgt
" " NQEMGF"qt"PQVNMF"0"PQVNMF"ecp"ko rn{"ugxgtcn"vjkipu<"vjg"u{uvgo"jcu"lwuv"uvctvgf.
" " vjgtg"ku"chcwnv"kp"vjg"IRU"Uwdu{uvgo"y jkej"jcu"ecwugf"PVR"vq"gvjgt"dg"wpcdng"vq"qdvckp
" " vk o kpi"kphtq o cvkqp"htq o "vjg"IRU"Uwdu{uvgo"qt"vq"tglgv"vjg"vk o kpi"kphtq o cvkqp"vjcv"kv"ku
" " qdvckkpi"htq o "kv0
```

```
-U0uuuuuuuu"ku"vjg"qhugv"kp"ugeqpfu"dgvy ggp"vjg"PVR"u{uvgo"enqem"cpf"vjg"IRU"Uwdu{uvgo"enqem0
" " Rqukvxg"ko rnku"vjcv"vjg"u{uvgo"enqem"ku"cjgcf"qh"vjg"IRU"Uwdu{uvgo0
```

```
NK"? "AA" ku"vjg"PVR"fcg o qp"ngcr"kp fkecvqt"dkvu0"Ngcr"ugeqpfu"qeewt"cdqwn"gxgt{"3 "vq"5"{gctu0"
" " Rqukdng"kp fkecvqt"xcnwg"ctg<
" " 22<" " Pqt o cn."nqemgf"qrgtcvkqp0
" " 23<" " Ngcr"ugeqpf"kpugtvpk"y knn"qeewt"chvgt"45<7;<7;"WVE0
" " 32<" " Ngcr"ugeqpf"fngvkv"y knn"qeewt"chvgt"45<7;<7;"WVE0
" "" 33<" " Hcwnv0"Wpu{pej tqpk|gf"uvcvgo
```

```
VHQO"? "A" ku"c"xcnwg"dgvy ggp"5"cpf";"cpf"kp fkecvgu"enqem"ceewtce{0
" " C"fgvckngf"gz rncpvkqp"qh"VHQO"ku"kp" 0
" "
```

```
[ GCT" ku"vjg"{gct"qh"vjg"WVE"vk o guvc o r"qh"vjg"o quv"tgegpv"wr fcvg"tgegxgf"htq o "vjg"IRU"Uwd
" " u{uvgo0
```

```
FQ[" ku"vjg"fc{/qh/{gct"qh"vjg"WVE"vk o guvc o r"qh"vjg"o quv"tgegpv"wr fcvg"tgegxgf"htq o "vjg"
" " IRU"Uwdu{uvgo0
```

J J<O O<UU""ku"vjg"j qwt." o k p w v g " c p f " u g e q p f " q v " v j g " W V E " v k o g u v c o r " q h " v j g " o q u v " t g e g p v " w r f c v g " t g e g k x g f ""  
" " h t q o " v j g " I R U " U w d u { u v g o 0

NU" ku"vjg"ewttgpv"pw o dgt"qh"ngcr"ugeqpfu"fkhhgtgpeg"dgv y ggp"vjg"WVE"cpf" I R U " v k o g u e c n g u  
" " \* 3 : " c v " v j g " v k o g " q h " v j k u " y t k v k p i + 0

Dgnqy"ku"cp"gzco r ng"qh"c"v{ rkecn"tgurqpug"vq"vjku"eq o o cpf<

" Eq o o c p f < " t z t t u b u

" U q p q o c " t g r n { <

!



**upgradkernel**

```
Vjku"wkknkv{"cnnqyu"{qw"vq"wr i tcf g"vjg"Nkpwz"mgtpgn0""Kv"ku"twp"chvgt"vjg"mgtpgn0 i /"Lng"jcu"dggp"eqrkf"
vq"vjg"lvor"fkgtgevt{"qp"vjg"u{uvgo0""Kv"rgthqtou"cp"gtcug"qh"vjg"wr i tcf g"mgtpgn"rctvkvqp"cpf"vjgp"
ytkvgu"vjg"lvor"mgtpgn0 i /"Lng"vq"kv0""Tghgt"vq"
" hqt"fgvckngf"kphqt o cvkqp0
```

```
" Eqo o cpf<" vqhsbef1fsofm
" Uppqoc"tgrn{<" Ujqyu"rtqitguu"kpfkcevqt0
```

**upgradercvr**

```
Vjku"wkknkv{"ku"pqv"cxckncdng"kp"wpkvu"ujkr rgf" dghqtg"Lwpg"42390""Kv"cnnqyu"{qw"vq"wr i tcf g"vjg"GpfTwp"
IRU" Tgegkxgt"Lt o yctg0""Ugg" "hqt" kphqt o cvkqp"qp"GpfTwp0u"
IRU" Tgegkxgt0""
```

```
Rtkqt"vq"gzgewvki"vjku"eqo o cpf."{qw"o wuv"eqr {"vjg"pgy"dkpct{"Lt o yctg"Lng"vq"lvor"ltext0dkp0""
```

```
Vjg"wkknkv{"uvctvu"vjg"Z/o qfg o "Lng"vtcpuhgt."cpf"vjgp"fkurnc{u"rtqitguu"vq"vjg"eqpuqng0""Ugg"
" hqt" o qtg" kphqt o cvkqp0
```

```
" Eqo o cpf<" vqhsbefsdws
" Uppqoc"tgrn{<" Writcf g"rtqitguu"ku"ujqyp0
```

**upgradercvrfpga**

```
Vjku"wkknkv{"ku"pqv"cxckncdng"kp"wpkvu"ujkr rgf" dghqtg"Lwpg"42390""Kv"cnnqyu"{qw"vq"wr i tcf g"vjg"Hkgnf/Rtq/
itc o o cdng" I cvg" Cttc{ "HR I C+"tgukf gpv"qp"vjg"GpfTwp" IRU" Tgegkxgt0""Ugg"
" hqt" kphqt o cvkqp"qp"GpfTwp0u" IRU" Tgegkxgt0""
```

```
Rtkqt"vq"gzgewvki"vjku"eqo o cpf."{qw"o wuv"eqr {"vjg"pgy"dkpct{"HR I C"Lng"vq"lvor"ltexthri c0dkp0""
```

```
Vjg"wkknkv{"uvctvu"vjg"Z/o qfg o "Lng"vtcpuhgt."cpf"vjgp"fkurnc{u"rtqitguu"vq"vjg"eqpuqng0""Ugg"
" hqt" o qtg" kphqt o cvkqp0
```

```
" Eqo o cpf<" vqhsbefsdwsgqhb
" Uppqoc"tgrn{<" Writcf g"rtqitguu"ku"ujqy
```

**upgraderootfs**

```
Vjku"wkknkv{"cnnqyu"{qw"vq"wr i tcf g"vjg"Nkpwz"tqqv"Lng"u{uvgo0""Kv"ku"twp"chvgt"vjg"tqqvhu0 i /"Lng"jcu"dggp"
eqrkf"vq"vjg"lvor"fkgtgevt{"qp"vjg"u{uvgo0""Kv"rgthqtou"cp"gtcug"qh"vjg"wr i tcf g"tqqv"Lng"u{uvgo"rctvk/
vkqp"cpf"vjgp"ytkvgu"vjg"lvor"lqqvhu0 i /"Lng"vq"kv0""Tghgt"vq"
" hqt"fgvckngf"kphqt o cvkqp00
```

```
" Eqo o cpf<" vqhsbefspugt
" Uppqoc"tgrn{<" Ujqyu"rtqitguu"kpfkcevqt0
```

upgradesubsys



get\_sw\_opts

Vjku"eq o o cpf"ku"fqew o gpygf"jgtg"hq"eq o ringvgpguu0""Vjg"jotubmmfe`tx`pqujpot"eq o o cpf"  
cdqyg"ku"owej"gcukgt"vq"wug0""Vjg"lfp`tx`pqujpot"eq o o cpf"tgywtpu"54/dkv"xcnwg"ykvj"gcej"dkv"kfpgpvk/



---

OPTIONS







Qt."{qw"ecp"wug"vjku"eququg"rqt"eq o o cpf<

```
" Eq o o cpf<"      dqvjpb
" Uppqoc"tgrn{<"  DQV!JOP!D! .!PQFO!DPMMFDUPS!BMSN!PVUQVU!jt!Jotubmmfc
```

### Direct Digital Synthesizer (DDS)

Vjg"FFU"Qrvkqp"rtqkfgu"wugt/ugngevcdng"rwnug"tcvgu"htq o "3" J |"vq"32" O J |."rtqitc o ocdng"kp"3"RRU"uvgru."kpenwfkpi"30766"ORRU"qt"4026:"ORRU0"Vjg"ugngevgf"rwnug"tcvg"ku"rjcug"nqemgf"vq"vjg"u{uvgo"quekncvqt"cpf"ku"pqv"cnkipgf"ykvj"u{uvgo"vkog0"

Vjg"FFU"ku"co"ou{uvgo"ukipcn0"Vjku"ogcpu"vjcv"vjgtg"ku"qpg"FFU"ukipcn"vjcv"chhgevu"vjg"yjqng"u{u/vgo0"kp"qvjgt"yqtfu."kh"{qwt"Uppqoc"jcu"o wnvkrng"FFU"qwrwvu"cpf"{qw"ejcpi g"vjg"rwnug"tcvg."vjgp"cn"FFU"qwrwvu"ykn'dg"chhgevgf0"

Vjg"rwnug"tcvg"ku"2" J |"y jgp"ujkr rgf"htq o "vjg"hcevqt{"dwv"ecp""dg"ejcpi gf"\*ugg"dgnq y +0"Hqt"fgvcknu"qp"vjg"FFU"ukipcn"fgLpkvkqp"ugg" 0

### View the DDS Connector

Qp"vjg"htqp/rcpgn"fkurnc{"vtcxgtug"vq"vjg"Ockp"Ogpw"cpf"vjgp"vq"ERWaklQ0"Vjku"fkurnc{"nkuvu"cp{"eqppgevqt"qp"vjg"ERW"Oqfwng"vjcv"jcu"cp"qrvkqpcn"klQ"ukipcn0"Eqppgevqtu"ctg"kfgpvkLgf"cu"C."D"qt"E0"Ugngev"vjg"rctvkewnct"eqppgevqt"\*klQ/C."klQ/D"qt"klQ/E+"vq"ugg"y jkej"ukipcn"ku"kpucvncngf0"

Qt."{qw"ecp"wug"vjku"eququg"rqt"eq o o cpf<

```
" Eq o o cpf<"      dqvjpb
" Uppqoc"tgrn{<"  DQV!JOP!D! Š!EJSF DU!EJHJUBM!TZOU!EJHJUBM!EJS!PVUQVU!jt!Jotubmmfc
```



" >UQJ@FFF<J J<OO<UUS>ET@>NH@

>UQJ@" ku"vjg"CUEKK"Uvctv/qh/ J gcfgt"ejctcevg"2z23+  
FFF" ku"vjg"fc{/qh/{gct  
<" " ku"vjg"eqnqp"ejctcevg"2z5C+  
J J" ku"vjg"jqwt"qh"vjg"fc{  
OO" ku"vjg"okpwwg"qh"vjg"jqwt  
UU" ku"vjg"ugeqpf"qh"vjg"okpwwg  
S" " kF Rg"O gQ wcnkv{"kp fkeAvf" @ fPoc{"dg"gvjgt<  
" " >urceg@" CUEKK"urceg"ejctcevg"2z42+"y jkej"kp fkecvgu"nqemgf  
" " A" " CUEKK"swgukqp"octm"2z5H+"y jkej"kp fkecvgu"  
" " " " vjg"w fkecvgu"no O O

OPTIONS

EndRunX (Extended) Format

Vjg"GpfTwpZ" hqt o cv"ku" kfgpvkecn"vq"vjg"GpfTwp" hqt o cv" ykvj"vjg"cf fkvkqp"qh"v yq"Łgnfu"/"vjg"ewt/
tgpv"ngcr"ugeqpf"ugvvpkiu"cpf"vjg"hwvwtg"ngcr"ugeqpf"ugvvpkiu0"Vjg"hqnnq ykpi"uvtkpi"ku"ugpv"qpeg"gcej"
ugeqpf<

" V" [ [ [ [ "FFF" J J<OO<UU" | \ \ "o"EE"HH>ET@>NH@

V" " ku"vjg"Vko g"Hkiwtg"qh"Ogtkv"ejctcevt"fguetkdgf"lp" 0
" " Vjku"ku"vjg"qp/vk o g"ejctcevt."vtcpu o kvvgf" fwtkpi"vjg"Łtuv" o knnkugeqpf"qh"gcej"ugeqpf0
[ [ [ [ " ku"vjg" {gct
FFF" ku"vjg"fc{/qh/{gct
<" " ku"vjg"eqnqp"ejctcevt"\*2z5C+
J J" ku"vjg"jqwt"qh"vjg"fc{
OO" ku"vjg" o kpwvg"qh"vjg"jqwt
UU" ku"vjg"ugeqpf"qh"vjg" o kpwvg
|" " ku"vjg"uki p"qh"vjg"qhugv"vq"WVE." - "k o rnkgu"vk o g"ku"cjgcf"qh"WVE0
\ \ " ku"vjg" o ci pkvwfg"qh"vjg"qhugv"vq"WVE"kp"wpkvu"qh" jcnh/jqwtu0
" " Pqp/|gtq"qpn{ "y jgp"vjg"Vko g o qfg"ku"Nqecn0
o" " ku"vjg"Vko g o qfg"ejctcevt"cpf"ku"qpg"qh<
" " I"?" IRU
" " N"?"Nqecn
" " W"?"WVE
EE" ku"vjg"ewttgpv"ngcr"ugeqpfu"xcnwg0"
HH" ku"vjg"hwvwtg"ngcr"ugeqpfu"y jkej" y km"ujqy" c"ngcr"ugeqpf"rgpfkpi"46"jqwtu"kp"cfxcpeg0
>ET@" ku"vjg"CUEKK"ecttkci g"tgwtp"ejctcevt"\*2z2F+
>NH@" ku"vjg"CUEKK"nkpghggf"ejctcevt"\*2z2C+

NENA Format

PGPC"ku"vjg"Pcvkqpcn"G o gti gpe{ "Pw o dgt"Cuuqekcvkqp0"Vjku"qti cpk|cvkqp"jcu"cfqrvvgf"ugxgtcn"CUEKK"
vk o g"eqfg" hqt o cvu" hqt" wug"kp"RUCRu"\*Rwdnke"Uchgv{ "Cpu y gtkpi"Rqkpvu+"cpf"vjg{ "ctg"urgekŁgf"kp"vjg"
PGPC"RUCR"Ocvgt"Enqem"Uvcpfctf."Kuuwg"60"Vjgug"CUEKK"vk o g"eqfg" hqt o cvu"ctg"PGPC"Hqt o cv"2"
\*PGPC2+."PGPC"Hqt o cv"3"\*PGPC3+."cpf"PGPC"Hqt o cv": "\*PGPC ; +<

>ET@>NH@S``FFF` J J<OO<UU` fV\ ?ZZ>ET@>NH@

S" " ku"vjg"vko g"swcnkv{ "kpfkecvqt"cpf" o c{ "dg"gvjgt<
" " >urceg@"CUEKK"urceg"ejctcevt"\*2z42+" y jkej" kpfkecvgu"nqemgf0
" " A"CUEKK"swgukqp" o ctm"\*2z5H+" y jkej" kpfkecvgu"vjg"wpu{pej tqpk|gf"eqpfkvkqp0
`" " ku"vjg"urceg"ejctcevt"\*2z42+0
FFF" ku"vjg"fc{/qh/{gct"\*223/588+
<" " ku"vjg"eqnqp"ejctcevt"\*2z5C+
J J" ku"vjg"jqwt/qh/vjg/fc{ "\*22/45+
OO" ku"vjg" o kpwvg/qh/vjg/jqwt"\*22/7 ; +
UU" ku"vjg"ugeqpf/qh/vjg/ o kpwvg"\*22/82+
f" " ku"vjg"FUV" kpfkecvqt"\*U.K.F.Q+0
V\ ?ZZ" ku"vjg"vko g" |qpg" y jgtg"ZZ"ku"22"vj tqwi j"45

```
>ET@"    ku"vjg"CUEKK"ecttkci g"tgwtp"ejctcevgt"*2z2F+0"
"      "    Vjg"Łtuv">ET@"ku"vjg"qp/vk o g"ejctcevgf0
>NH@"    ku"vjg"CUEKK"nkpghggf"ejctcevgt"*2z2C+0
```

```
>ET@>NH@S` Y Y Y ` F F O O O [ [ ` J J < O O < U U > E T @ > N H @
```

```
S " "    ku"vjg"vk o g"swcnkv{"kpfkecvqt"cpf" o c{"dg"gvjgt<
"      "    >urceg@"CUEKK"urceg"ejctcevgt"*2z42+"y jkej"kp fkecvgu"nqemgf0
"      "    A"CUEKK"swgvkqp" o ctm"*2z5H+"y jkej"kp fkecvgu"vjg"wpu{pej tqpk | gf"eqp fkvkqp0
` " "    ku"vjg"urceg"ejctcevgt"*2z42+0
Y Y Y "  ku"vjg"fc{/qh/yggm"*OQP."VWG."YGF."VJW."HTK."UCV
FF"      ku"vjg"fc{/qh/oqpvj"*3/53+
O O O "  ku"vjg" o qp v j "*LCP."HGD."OCT."CRT."OC[."LWP."LWN."CWI."UGR."QEV."PQX"FGEG+
[ [ "    ku"vjg"v y q / f k i k v " { g c t
< " "    ku"vjg"eqnqp"ejctcevgt"*2z5C+
J J "    ku"vjg"j q w t / q h / v j g / f c { " * 2 2 / 4 5 +
O O "    ku"vjg" o k p w v g / q h / v j g / j q w t " * 2 2 / 7 ; +
U U "    ku"vjg"ugeqpf/qh/vjg/ o k p w v g " * 2 2 / 8 2 +
>ET@"    ku"vjg"CUEKK"ecttkci g"tgwtp"ejctcevgt"*2z2F+0"
"      "    Vjg"Łtuv">ET@"ku"vjg"qp/vk o g"ejctcevgf0
>NH@"    ku"vjg"CUEKK"nkpghggf"ejctcevgt"*2z2C+
```

```
>ET@>NH@S`` [ [ [ [ F F F ` J J < O O < U U ` F - \ \ > E T @ > N H @
```

```
S " "    ku"vjg"vk o g"swcnkv{"kpfkecvqt"cpf" o c{"dg"gvjgt<
"      "    >urceg@"CUEKK"urceg"ejctcevgt"*2z42+"y jkej"kp fkecvgu"nqemgf0
"      "    A"CUEKK"swgvkqp" o ctm"*2z5H+"y jkej"kp fkecvgu"vjg"wpu{pej tqpk | gf"eqp fkvkqp0
` " "    ku"vjg"urceg"ejctcevgt"*2z42+0
[ [ [ [ "  ku"vjg"hqwt/fkikv" { g c t
F F F "    ku"vjg"fc{/qh/{gct"*223/588+
< " "    ku"vjg"eqnqp"ejctcevgt"*2z5C+
J J "    ku"vjg"j q w t / q h / v j g / f c { " * 2 2 / 4 5 +
O O "    ku"vjg" o k p w v g / q h / v j g / j q w t " * 2 2 / 7 ; +
U U "    ku"vjg"ugeqpf/qh/vjg/ o k p w v g " * 2 2 / 8 2 +
f " "    ku"vjg"FUVPkpfkecvqt"*U.K.F.Q+0
- \ \ "    - "qt"/"vk o g | qp g " q h h u g v " t g n c v k x g " v q " W V E " * 2 2 / 3 4 +
>ET@"    ku"vjg"CUEKK"ecttkci g"tgwtp"ejctcevgt"*2z2F+0"
"      "    Vjg"Łtuv">ET@"ku"vjg"qp/vk o g"ejctcevgf0
>NH@"    ku"vjg"CUEKK"nkpghggf"ejctcevgt"*2z2C+0
```

#### NMEA Format

```
Vjg" Pcvkqpcn" Octkpg"Gngevtqpkcu"Cuuqekcvkqp"*P OGC+"jcu"fgxgnqrgf" c"urgekŁecvkqp"vjcv"fgŁpgu"vjg"
kpv gthceg" d g v y g g p " x c t k q w u " r k g e g u " q h " o c t k p g " g n g e v t q p k e " g s w k r o g p v 0 " " V j k u " u v c p f c t f " f g Ł p g u " o ů g p v g p e g u 0 "
```



v jcv"eqpvckp" I RU"rqukvkqp."pcxki cvkqp."vk o g."cpf"qv jgt"kpht o cvkqp0""Ugpgvpegu"vj cv"jcxg"dggp"ko rng/  
ogpvgf"kp"vjg"Uqpq o c"eqphqt o "vq" P OGC/23 : 5"UrgekŁecvkqp"Xgtukqp"50230""

[qwt"Uqpq o c"ecp"qwrwv"qpg."vyq."qt"vj tgg"qh"vjgug"ugpvpegu"rgt"ugeqpf0""Vjg"Łtuv"ej ctcevgt"\*õ&õ+"qh"  
vjg"Łtuv"ugpvpegu"ku"vjg"õqp/vk o gõ"ej ctcevgt0""Qpeg"vjg"wpkv"ku"hqemgf"vq" I RU."vjg"õqp/vk o gõ"ej ctce/  
vgt"uvctu"vtcpu o kvkpi "ykvjkp"vjg"Łtuv"42" o ketqugeqpfu"qh"gej "ugeqpf0""Gcej"ugpvpegu"ku"vtcpu o kvkpf"  
ykvjkp"722" o knnkugeqpfu"chvgt"vjg"3RRU" rwnug0"Ugg"fkci tc o "dgnqy0

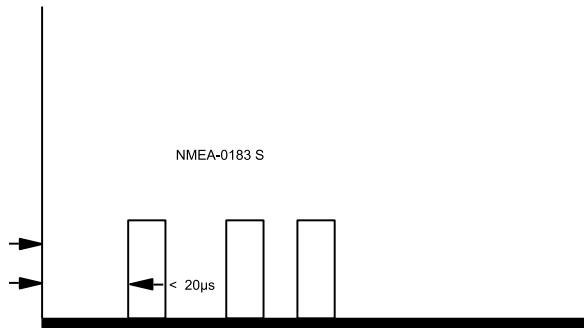

Hkgnf"33" g o r v { "Łgnf" J g k i j v " q h " i g q k f " \* o g c p " u g c " n g x g n +  
 Hkgnf"34" g o r v { "Łgnf" W p k v u " q h " i g q k f c n " u g r c t c v k q p  
 Hkgnf"35" g o r v { "Łgnf" V k o g " k p " u g e q p f u " u k p e g " n c u v " F I R U " w r f c v g  
 Hkgnf"36" g o r v { "Łgnf" F I R U " u v c v k q p " K F " p w o d g t  
 E j g e m u w o " , 94  
 O u i " G p f " > E T @ > N H @

V j g " I N N " u g p v g p e g " k f g p v k Ł g u " v j g " r q u k v k p " Ł z . " v k o g " q h " r q u k v k p " Ł z . " c p f " u v c v w u 0 " " G z c o r n g u " c t g " d g n q y <

& I R I N N . . . . . X . P , 86 > E T @ > N H @

& I R I N N . 5 : 49 0 2 5 2 . P . 34466 0 242 . Y . 395645 0 22 . C . C , 56 > E T @ > N H @

O u i " K F " & I R I N N  
 Hkgnf"3" 5 : 49 0 2 5 2 " N c v k w f g " k p " f f o o 0 o o o  
 Hkgnf"4" P " " F k t g e v k q p " q h " n c v k w f g " \* P ? p q t v j . " U ? u q w v j +  
 Hkgnf"5" 34466 0 242 " N q p i k w f g " k p " f f f o o 0 o o o  
 Hkgnf"6" Y " " F k t g e v k q p " q h " n q p i k w f g " \* Y ? y g u v . " G ? g c u v +  
 Hkgnf"7" 395645 0 22 " W V E " v k o g " q h " Ł z " \* j j o o u u 0 u u +  
 Hkgnf"8" C " " C ? f e v c " x c n k f . " X ? f e v c " p q v " x c n k f  
 Hkgnf"9" C " " C ? c w v q p q o q w u " o q f g . " P ? f e v c " p q v " x c n k f  
 E j g e m u w o " , 56  
 O u i " G p f " > E T @ > N H @

V j g " I U C " u g p v g p e g " k f g p v k Ł g u " v j g " I R U " r q u k v k p " Ł z " o q f g . " v j g " U c v g n k v g " X g j k e n g u " \* U X u + " w u g f " h q t " p c x k /  
 i c v k q p . " c p f " v j g " F k n w v k q p " q h " R t g e k u k q p " \* F Q R + " x c n w g u 0 " " F Q R " k u " c p " k p f k e c v k q p " q h " v j g " g h h g e v " q h " u c v g n k v g "  
 i g q o g v t { " q p " v j g " c e e w t c e { " q h " v j g " Ł z 0 " " C p " g z c o r n g " k u " d g n q y <

& I R I U C . C . 3 . . . . . , 3G > E T @ > N H @

& I R I U C . C . 5 . 3 : . 5 . 44 . 8 . ;



Hkgnf";" C" " C?cwwppq o qwu" o qfg."P ? fcv"pqv"xcnkf  
 Ejgemuw o" ,96  
 Oui"Gpf" >ET@>NH@

Vjg" \ FC"ugpvgepeg"kf gpvkLgu"vjg"vk o g"cuuqekcvgf" y kvj"vjg"ewttgpv"3RRU" rwnug0"Gcej"ugpvgepeg"ku"  
 vtcpu o kvvgf" y kvj kp"722" o knnkugeqpfu"chvgt"vjg"3RRU" rwnug"ku"qwwrww"cpf"vgmu"vjg"vk o g"qh"vjg" rwnug"vjcv"  
 lwuw"qeewttgf0"kh"vjg"Uqpq o c"ku"wpu {pej tqpk |gf"vjgp"vjku"ugpvgepeg" y knn"dg"eq o rqugf"qh"pwnn"Lgnfu0"  
 Gzc o rngu"ctg"dgnqy<

& IR \ FC.....,6:>ET@>NH@  
 & IR \ FC.39787:022.42.27.422:.29.22,8;>ET@>NH@

Oui"KF" & IR \ FC  
 Hkgnf"3" 39787:022" WVE"vk o g"cv"3RRU"\*jj o o uu0uu+ "  
 Hkgnf"4" 42" " Fc{ "23"vq"53+  
 Hkgnf"5" 27" " Oqpvj"\*23"vq"34+  
 Hkgnf"6" 422:" " [gct"\*3; :2"vq"429;+  
 Hkgnf"7" 29" " Nqecn"vk o g" |qpg" j qwt."qhhugv"htq o "WVE"\*/"hqt"gcuv"nqpi kwvfg+  
 Hkgnf"8" 22" " Nqecn"vk o g" |qpg" o kpwwgu."qhhugv"htq o "WVE  
 Ejgemuw o" ,8;  
 Oui"Gpf" >ET@>NH@

## Power Supply Options

[qwt"Uqpq o c"ecp"dg"eqpLi wtgf" y kvj"ugxgtcn"qr vkqpcn" r qygt"uwr rn{ "kprwvu" y jkej"ctg"nkuvgf"kp"  
 0" Fwcn/tgfwfcpv" r qygt"uwr rnkgu"ctg"cuq"cxckncdng0"

### DC Power Input

Vjg"FE" r qygt" kprwv" wugu" c"5/rqukvqp"vgt o kpcn"dnqem"cpf"tgrncegu"vjg"uvcpcfctf"CE" r qygt" kprwv"  
 lcem0

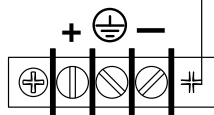

**SHOCK / ENERGY HAZARD**

Install in Restricted Access Location.

Use 10-14 AWG copper wire only.

Terminal block screw torque: 9 lb-in (1 nÇM).

Branch circuit must have circuit breaker, 15A or less.

Power must be sourced via two pole disconnect device.

Install terminal block cover after wiring.

**Dual-Redundant Power Supplies**

Cp{"eq o dkpcvkqp"qh"Wpkxgtucn"CE"cpflqt"FE"uwr rnkgu"ku"cxckncdng0""Rtk o ct {"cpf"ugeqpfct {" rqygt" uwr rnkgu"ctg"eqppgevgf"kp" c"fwcn/tgfwfcpv"eqpŁiwtcvkqp" ykvj" jkvnguu"cwvq o cvke" rtk o ct { /vq/ugeqpfct {" cpf"ugeqpfct { /vq/rtk o ct {"uykvejxqgtf0

C"hcwnv"fgvgevqt" o qpkvqtu"vjg"uvcvwu"qh"gcej"tgfwfcpv"rqygt"uwr rn{0""Y jgp" c"hcwnv"ku"fgvgevfgf"kv" yknn" vtkiigt" c"u{uvgo "cncf o 0""Y jgp"Uqpq o c"ku"eqpŁiwtgf" ykvj" Fwcn"Rqygt"Uwr rnkgu."cp"ncf o "yknn"ujqy"kh" vjg"rtk o ct {"qt"ugeqpfct {"uwr rn{ "fqgu"pqv"jcxg"rqygt"eqppgevgf0

**Masking Dual Power Supply Fault Alarms**

[qw"ecp" o cum"vjg"Rtk o ct {"cpf"Ugeqpfct {"Hcwnvu"vq"rtgxgpv"vjg" o "htq o "ecwukpi" c"u{uvgo "cncf o 0"" Ocumkpi" c"hcwnv" yknn"rtgxgpv"kv"htq o "ecwukpi" vjg"Cncf o "NGF"cpf"Cncf o "Qwvrwv"\*kh"cp {"+htq o "i qkpi" cevkg0""Ocumkpi" c"hcwnv" yknn" PQV"rtgxgpv"kv"htq o "ujqy kpi" qp"vjg"htqpv/rcpgn"U{uvgo "Hcwnvu"fkurnc {" qt"kp"vjg" **hqt tubu**"eq o o cpf0"

Vq" o cum"vjg"hcwnv."vtcxgtug"vq"vjg"Hcwnvu"Ogpw."vjgp"ugngev"Ry tHnv"Ocum0""Qt." {qw"ecp"wug"vjg"eqpuqng" eq o o cpf u" **qxsgmunbt1**"cpf" **tfuqxsgmunbt1**0""Rctc o gvgtu"ctg"gvjgt"Ocumgf"qt"Gpcdngf0""Ugvvki" vjku"eq o o cpf"vq"Ocumgf" yknn"rtgxgpv" c" r qygt"uwr rn {"hcwnv"htq o "etgcvkpi"cp"ncf o "eqpfkvkqp0""Vjg" hcevqt {" fghcwnv"ugvki"ku"Gpcdngf0

" Eq o o cpf<" **qxsgmunbt1**  
 " Uqpq o c"tgrn{<" **Qs jnbsz ! Qpxfs ! Joqv u ! Gbvmu ! Bmbsn ! jt ! NBT LFE**  
 ! ! ! **Tfdpoeb "**





## Display and Keypad Operation

Vjg"fkurnc{" o gpwu"ctg"qti cpk|gf"cu"ujqyp"dgnqy<

### Traversing the Display Structure

Chvgt"rqygt"kpvkcnk|cvkqp"vjg"y gneq o g" o guuc i g" y knn"cr r gctl""Rtguu"cp{"mg{"vq" i q"vq"vjg"Vk o glUvcvwu"fkurnc{." y jke j"ku" fguetkdgf"dgnqy0""Htq o"vjg"Vk o glUvcvwu"fkurnc{."rtguu"GPVGT"qt" FQY P"vq" i q"vq"vjg"Ockp"Ogpw0""Cu"knwuvtcvgf"kp"vjg"fk i t c o"cdq xg."ugxgten"uvcvwu"cpf"ugvwr"fkurnc{u"ctg"ceeguukdng"htq o"vjg"Ockp"Ogpw0""Vq" i q"fqyp y ctf"vj tqw i j"vjg"uvtwevwtg"wug"vjg"TK I J V"cpf"NGHV"cttq y"mg{u"vq"jki jnk i j v" c"ugngevkqp"cpf"vjgp"rtguu"GPVGT"qt" FQY P0""Vq" i q"dcem"wr"vj tqw i j"vjg"uvtwevwtg"rtguu"DCEM"qt"WR"vq"tgvwtp"vq"vjg"rtgxkquw"fkurnc{0"

### Editing

Vq" o



### Keypad EDIT Lockout

Cu'c'ugewtkv{"hgcvtg."{qw"ecp"fkucdng"cnn"gfkvkpi"rtqeguugu"fppg"vj tqwi j"vjg"htqpv/rcpgn"mg{rcf0""Fq"  
vjku"vq"rtxgpn"wpcwvjqt|gf"o qfkLecvkqp"qh"vjg"kpvtw o gpv0""Y jgp"vjg"GFKV"mg{"jcu"dggp"fkucdngf."c"  
yctkpi"o guuci g"yknn"cr rget"y jgpgxgt"c"wugt"vtkgu"vq"gfkv"c"rctc o gvg0""Vq"gpcdng"vjg"nqemqvw"hgcvwtg"  
wug"vjg"mpdlpvulq"eq o o cpf"cu"fguetkdgf"kp" 0""Vjg"  
nqemqvw"hgcvwtg"y knn"rtxgpn"gfkvkpi"qpn{."vjg"fkurnc{u"ctg"cnyc{u"cxckncdng"hqt"xkgykpi0

### Using Help

Rtguu"JGNR"cv"cp{"vk o g"vq"tgc f"vjg"eqpvgzv/ugpvkxg"jgnr"o guuci gu0""Wug"WR"cpf"FYYP"vq"uetqm"  
vj tqwi j"vjg"jgnr"o guuci g0""Rtguu"vjg"JGNR"mg{"c"ugeqpf"vk o g"vq"gzkv"Jgnr"\*qt"rtguu"DCEM+0

### Shortcut Menu

Vjg"Ujqtvevw"Ogpw"cnnyu"vjg"wugt"swkem"ceeguu"vq"rctvkewnc"fkurnc{u"htq o "vjg"Vko glUvcvwu"fkurnc{0"  
Vjg"fkurnc{u"cxckncdng"vj tqwi j"vjg"Ujqtvevw"Ogpw"ctg"vjg"Tgegkxgt"Uvcvwu."IRU"Thgtgpeg"Rqukvkqp."  
Hcwnvu."cpf"PVR"Uvcvwu0""Vq"ugngev"vjg"Ujqtvevw"Ogpw 'uu"J?Vq"ug u

Tgegkxgt"Uvcvwu<"" IRU"Uwdu{uvgo!Tgegkxgt"uvcvwu"cu"hqmqyu<  
" " " YTO<" " Yctowr"rgtkqf"hqt"wpkvu"ykvj"quekncvqt"wr itc fgu)  
" " " CES<" " Ceswtkpi0""Ugctejkpi"hqt"u"ukipcn0  
" " " NMI<" " Nqemkpi"vq"vjg"IRU"ukipcn0  
" " " NMF<" " Nqemgf0""Hwnn{"u{"pej tqpk|gf"vq"ukipcn0

U{uvgo"Uvcvwu<"" kpfkecvgu"gvjgt"QM"qt"fcujkpi"HCWNV0""C"hcwnv"uvcvwu"kpfkecvgu"vjcv"qpg"qt"o qtg  
" " " qh"vjg"dwknv/kp"hcwnv"ejgemkpi"rtqeguug"jkwfgyvevgf"cp"gttqt"eqpfkvkqp0""Ugg"  
" " " "kp"vjku"ejcrvgt"hqt"o qtg"phqtocvkqp0

Cp"cnvgtpcvg"Vko glUvcvwu"fkurc{"ecp"dg"xkgygf"d{"rtguukpi"vjg"tkijv"cttqy"mg{0"" [qw"ecp"iq"dcem"vq"  
vjg"qtkikpek " "

VHQO<"" " Vjku"ku"cxnwg"dgv y ggp"5"cpf";"cpf"kp fkecvgu"enqem"ceewtce{0  
 " " " C"fgvckngf"gz rncpcvkqp"qh"VHQO"ku"kp" 0

%"qh"UXu<" " Vjku"ujqyu"vjg"pwo dgt"qh"ewttgpn{"vtcemu"Ucvgnkv"Xgjkengu"htqo"2"vq"340

Cxi"ElPq<"" " Vjg"ecttkt/vq/pqkug"tcvkq"ku"cp"kp fkecvqt"qh"vjg"IRU"uki pcn"swcnk{0""Vjku  
 " " " pw o dgt"v{rkecn{"tcpigu"htqo"52"vq"67"fd"y jgp"vjg"kp uvtw o gpv"ku"nqemgf0

UX"KF%<"" " Vjku"Łgnf"nkuv"vjg"ucvgnkv"xgjkengu"vjcv"ctg"ewttgpn{"dgkpi"vtcemgf0

Receiver: Satellite Vehicle Information (SV\_Info)

Vjku"fkurnc{"ujqyu"vjg"ejcppgn"pwo dgt."UX"pwo dgt."c|k o wvj."gngxcvkqp"cpf"vjg"ecttkt/vq/pqkug"tcvkq"  
 \*ElPq+"hqt"cnm"34"ejcppgn"qh"vjg"34/ejcppgn"IRU"tgegkxgt0""UX"pwo dgt"2"ku"cp"kp xcnkf"pwo dgt"cpf"  
 kp fkecvgu"vjcv"pq"ucvgnkv"ku"dgkpi"vtcemgf"qp"vjcv"ejcppgn0""Xcnkf"UX"pwo dgtu"tcpig"htqo"3"vq"540"  
 C|k o wvj"cpf"ngxcvkqp"ctg"kp"fgitggu"cpf"ElPq"ku"kp"fd0

Receiver: Reference Position (Ref\_Pos)

Vjku"fkurnc{"ujqyu"vjg"ewttgpn"IRU"tghgtpeg"rqukvkqp"cpf"cnnyu{"qw"vq"gpvgt"crqukvkqp."kh"fguktgf0"  
 Vjg"IRU"tghgtpeg"rqukvkqp"ku"vjg"rqukvkqp"qh"vjg"IRU"cpvppc0"Ceewtcvg"rqukvkqp"ku"pgeguuct{"vq"  
 igpgtcvg"rtgekug"vkog"cpf"htgswgpe{"qwwrvvu0

Vjg"rqukvkqp"ku"ujqyp"cu"ncvkwfg."nqpi kwfg"cpf"ngxcvkqp0""Ncvkwfg"cpf"nqpi kwfg"ctg"ujqyp"cu"  
 jgokurjgtg\*"Pqtvj."Uqwj."Gcuv."Yguv+."fgitggu."okpwvgu"cpf"ugeqpfu0""Gngxcvkqp"ku"ujqyp"kp"ogvgtu"  
 cdqxs"vjg"YIU/:6"gnkrqukf0

Vjg"uqwteg"Łgnf"\*UTE+"kp fkecvgu"vjg"uqwteg"qh"vjg"rqukvkqp"kpht o cvkqp0""Rquukdn"xcnwg"ctg"ōwp/  
 mpqypō."ōcxgtcigō"cpf"ōwugtō0""Yjgp"Łtuv"kpucnngf."vjg"rqukvkqp"uqwteg"yknn"dg"ōwmpmpqypō0""Kv"  
 ejcpigu"vq"ōcxgtcigō"chvgt"vjg"tgegkxgt"jcu"eqorwvfg"vjg"Łtuv"5/fk"ogpukqpcn"rqukvkqp"Łz0""Vjg"rqu/  
 vkqp"eqpvkpwgu"vq"dg"cxgtcigf"ht"cdqww"46"jqwtu0""Eqorwvcvkqp"tgs wktgu"vjcv"c"okpkowo"qh"6"qt"  
 oqtg"ucvgnkv"dg"kp"xkgy0""

Ykvj"ctqhqvr"cpvppc"kpucnncvkqp"vjcv"jcu"cp"wpqduewtgf"xkgy"qh"vjg"um{g"o%o

```
" " rqukvkqp0""Qpeg"vjg"tgegkxgt"jcu"eqo rwwgf"c"pgy"ceewtcvg"tghgtgpeg"rqukvkqp"vjg"rqukvkqp
" " uqwteg"yknn"ejcpi g"htqo "öwmpmpqy pö"vq"öcxgtci gö0
```

```
Wugt< Ugngevkpi "öwugtö"yknn"cnny" {qw"vq"gpvgt"c"rqukvkqp0""Kv"ku"xgt { "k o rqtvcpv"vjcv"vjg"pgy
" " tghgtgpeg"rqukvkqp"dg"ceewtcvg0""Tghgt"vq"
hqt"fgvckngf"kpuvtwewkqpu"qp"jqy"vq"qdvckp"cp"ceewtcvg"tghgtgpeg
" " rqukvkqp"hqt" {qwt"nqecvkqp0
```

## Receiver: Last Fix Position (Last\_Fix)

```
Vjku"fkurnc { "rtqxfgu"vjg"ncuv"eqo rwwgf" I RU"rqukvkqp0""Y jgp"vtcemkpi "hqt"qt" o qtg"ucvgnkvgu."vjg"
I RU"Tgegkxgt"rtqxfgu"c"5F/rqukvkqp"Łz0""Y jgp"qpn { "vj tgg"ucvgnkvgu"ctg"kp"xkgy."vjku"yknn"ftqr"vq"
c"4F/rqukvkqp"Łz0""V jg"ncuv/Łz"rqukvkqp"ku"pqto cnn { "nguu"ceewtcvg"vjcp"vjg"tghgtgpeg"rqukvkqp."dww"kv"
fqgu"rtqxfgu"c"i qgf"kp fkecvkqp"vjcv"vjg"tgegkxgt"ku"y qtmkpi "rtqr gtn {0""Rqukvkqp"ku"rtqxfgf"kp"ncvkwf g."
nqpi kwf g"cpf"jgki jv0
```

## Receiver: UTC Information (UTC\_Info)

```
Vjku"fkurnc { "ujqyu"vjg"WVE"Kphqt o cvkqp"y jkej"kpenwfgu"ngcr"ugeqpfu"*NU+"cpf"hwvwtg"ngcr"ugeqpfu"
*NUH+"hqt"vjg"yggm"pw o dgt"*Y Panuh+"cpf"fc { "pw o dgt"*FP+"fkurnc { g f0""Kv"enuq"ujqyu"vjg"KEF/ I RU/
422"cn o cpce"rctc o gvgtu"y jkej"ctg"wugf"vq"ecnewncvkv"vjg"qhhugv"dgvy ggp"WVE"cpf" I RU"vk o gl0""V jgug"
kpenwfg"rctc o gvgtu"htq"fgvgt o kpkpi "ngcr"ugeqpfu"cpf"vjg"rctc o gvgtu"htq"ecnewncvkvpi "vjg"u o cnn"tgukfwcn"
qhhugv"dgvy ggp"vjg" I RU" o cuvgt"enqem"gpug o dng"cpf"WVE/WUPQ0""V jku"ncvgt"xcnwg"ku"v { rkecnn { "nguu"
vjcp"32"pcpqugeqpfu0""Rtguu" J GNR"vq"tgc f" o qtg"fgvckngf"Kphqt o cvkqp"qp"vjg"Łgnfu"ujqyp"kp"vjku"
fkurnc {0
```

## Receiver: Dynamic Mode (Dyn\_Mode)

```
Vjg" I RU" f { pc o ke" o qfg"ugvvpki "chhgevu"vjg"rqukvkqp"xcnwg"wugf"d { "vjg"u { uvgo "vq"fgtkxg"ceewtcvg"vk o g"
u { pej tqpk | cvkqp0""Kp" f { pc o ke" o qfg."vjg"cxgtci g"rqukvkqp"ku"fkurnc { g f"cu"vjg"ewttgpv"rqukvkqp."kp"qvjgt"
y qtfu"/"vjgtg"ku"pq"rqukvkqp"cxgtci kpi 0""
```

```
Kv"ku"k o rqtvcpv"vq"ugv"vjg" o qfg"vq"öQHH"*ucvke"kpucvncvkvqp+ö" y jgp"vjg"kpuvtw o gpv"ku"kp"c"ucvke"kpucvnc/
ncvkvqp0""V jku"ku"vjg"hcvtq { / fghcwnv"ugvvpki 0""Ugv"vjg" o qfg"vq"öQP"* f { pc o ke"kpucvncvkvqp+ö"QPN [ "kh"vjg"
kpuvtw o gpv"ku"kpucvncvkvqp"c" o qxkpi "rncvhtq o "*ujkrdqctf"qpn { +0
```

## Receiver: Oscillator Status (Osc\_Stat)

```
Vjku"fkurnc { "rtqxfgu"vjg"u { uvgo "quekncvqt"ucvuwu"Kphqt o cvkqp"y jkej"kpenwfgu"quekncvqt"v { rg"cpf"
nggevtqpk"htgswgpe { "eqpvtqn"ucvuwu0""V jg"quekncvqt"eqpvtqn" FCE"xcnwg"kp fkecvgu"vjg"htgswgpe { "eqpvtqn"
ugvvpki 0""V jg"u { uvgo "cwwq o cvkecnn { "ugvu"vjku"xcnwg"vq"tg o qxg"htgswgpe { "gttqtu0""Xcnwgu" o c { "tcpig"htq o"
2"vq"3.26: .7970""Xcnwgu"enqug"vq"vjg" o kpk o w o "qt" o czk o w o "y knn"ugv"vjg" FCE"hcwnv" İci"vjcv"yknn"cr r gct"
kp"vjg"hcwnv"ucvuwu"fkurnc {0""V jg"V k o glUvcvuwu"fkurnc { "y knn"enuq"kp fkecvg"c"hcwnv"eqpfkvkqp0
```

```
Vjg"quekncvqt"v { rg"kp fkecvgu"vjg"quekncvqt"vjcv"ku"kpucvncvkvqp0""Rqukdng"quekncvqt"v { rgu"ctg<
```

```
" Vg o rgtcvwtg/eqo rgpucvfg"et { uvcn"quekncvqt"*VEZQ+"
" Qxgp/eqpvtqmgf"quekncvqt"*QEZQ+
" Twdkfw o "quekncvqt"*Td+
```

Receiver: Calibrate

Ecnkdtcvg"ku"wugf"vq"ugv"vjg"cpvgppc"rtqrc"icvkqp"fgnc{0""Vjku"yknn"cfxcpeg"qt"tgvcft"vjg"enqem"kp"qtfgt"  
vq"eqttgev"hqt"cpvgppc"ecdng"ngpi"vj"qt"vq"eq"o"rgpucvg"hqt"vjg"kpjgtgpv"vk"o"qhhugvu"vjcv"oc{"gzkuv"ykvj"  
gzvgtpcn"jctfyctg"uwej"cu"fkvktkdwkqp"co"rnkLgtu."gve0""Ecnkdtcvkqp"tcpig"ku"0722.222"pcpqugeqpfu0

Faults Menu

Vjg"Hcwnvu"Ogpw"ku"ugngevgf"htq"o"vjg"Ockp"Ogpw"cpf"rtqxfgu"ceeguu"vq"xkgy"vjg"U{uvgo"Hcwnvu"cpf"  
vq"ugv"hcwnv"ocumu"hqt"vjg"Cpvgppc"Hcwnv"cpf"vjg"Ukicipu"Nquu"Hcwnv0

Faults: System

Cnn"u{uvgo"hcwnvu"ctg"ujqyp"qp"vjku"fkurnc{"cpf"vjgkt"ewttgppv"uvcvwu."gkvjgt"QM"qt"HCWNV0""Yjgp"c"  
hcwnv"eqpfkvpq"gzkuv"vjg"HNV"kpfkcevqt"yknn"fcuj0""

Vjgug"hcwnv"kpfkcevqtu"ctg"vjg"uc"og"cu"vjg"eqttgurqpfpki"dkv"rqukvkqpu"ujqyp"kp"vjg"hqt"tubu"hcwnv"  
uvcvwu"yqtf"\*HNVU+0""\*Ugg" "hqt"kphqt"ocvkqp"qp"hqt.  
tubu0""Wpwugf"dkv"rqukvkqpu"ujqy"qp"vjg"fkurnc{"cu":  
o

```

" HNUJ" IRU"Tgegkxgt"HNCUJ"Ytkvgu
" HRI C" IRU"Tgegkxgt"HRI C"EqpŁiwtcvkqp
" UKI" IRU"Uki pcn
" FCE" Tgegkxgt"Queknncvqt" FCE

" QUE" Tgegkxgt"Queknncvqt
" TGH" IRU"Tghgtgpeg"Vko g
" U [ P4" Nqecn"Queknncvqt"U{pvjguk|gt"Vwplpi
" U [ P3" Nqecn"Queknncvqt"U{pvjguk|gt

" RNN" Queknncvqt"RNN
" QRGp" Cpvppc"Qrgp
" UJTV" Cpvpc"Ujqtv
"

```

#### Faults: Antenna Fault Mask (AntFltMask)

```

Vjku"ugvvpki"cnmqyu" {qw"vq"rtgxgp"vjg"cpvppc"hcwnv"htqo"etgcvkpi"cp"cncto"eqpfkvkp0""Uqog"kpucnnc/
ncvkqpu"oc{"pggf"vq"ocum"vjku"hcwnv"fwg"vq"urgeken"cpvppc"ukvvcvkqpu"nkmg"urnkvgtu"qt"FE"dnqemu"vjcv"
eqphwug"vjg"cpvppc"fgvgevkqp"ektewkv0

```

#### Faults: Signal Loss Fault Mask (SigFltMask)

```

Vjku"ugvvpki"cnmqyu" {qw"vq"rtgxgp"v"uki pcn"nquu"hcwnv"htqo"etgcvkpi"cp"cncto"eqpfkvkp0""Uqog"kpucnnc/
vkqpu"oc{"pggf"vq"ocum"vjku"hcwnv"y jgp"qrgtcvkpi"vjg"PVr"ugtugt"cu"Uvtcvw"o"4"ugtugt0""

```

#### Optional Faults: Dual Power Input Fault Alarm Masks (PwrFltMask)

```

Vjku"ugvvpki"cnmqyu" {qw"vq"rtgxgp"v"r tk oct {"qt"ugeqpfct {"rqygt"uwr rn {"hcwnv"htqo"etgcvkpi"cp"cncto"
eqpfkvkp0""Ugg" "hqt"o qtg"kphqt/
ocvkqp0

```

#### Optional System I/O Menu (Sys\_I/O)

```

Vjg"U{uaKIQ"Ogpw"ku"wugf"hqt"xkgykpi"cpf"eqpŁiwtkpi"qrvkqpcn"u {uvgo/ykfg"qwwrvw"ukipcnu0""Ugg"
"hqt"o qtg"kphqtocvkqp0

```

#### Optional CPU Module I/O Menu (CPU\_I/O)

```

Vjg"ERWaKIQ"Ogpw"ku"wugf"hqt"xkgykpi"cpf"eqpŁiwtkpi"qrvkqpcn"ERW"Oqfwng"qwwrvw"ukipcnu0""Ugg"
"hqt"o qtg"kphqtocvkqp0

```

#### Network Menu

```

Vjg"Pgvy qtm"Ogpw"ku"ugngevgf"htqo"vjg"Ockp"Ogpw"cpf"rtqxfgu"ceeguu"vq"Pgvy qtm6."Pgvy qtm8."cpf"
TGDQQV"fkurnc {u"y jke j"ctg"fguetkdgf"dgngy0

```

Network: Network4

Vjku"fkurnc{"rtqxfgu"vjg"cdknkv{"vq"xkgy"cpf"oqfkh{"vjg"KRx6"pgvyqtm"ugvvpku"Vjg"rctcogvgtu"kpwnwfg"J{pcoke"Jquv"EqpLiwtcvkqp"Rtqvqeqn"FER+"KR"cfftgau."icvgyc{.pgv"ocum"cpf"fq"ockp"pcog"ugtxgt"FPU+"ugvvpku"Gpcdnng"FER"vq"cnmqy"cwvq"ocvke"u{uvgo"eqpLiwtcvkqp"qh"vjg"pgvyqtm"kpvgthceg"Yjgp"FER"ku"fkucdnng"vjg"wugt"owuv"rtqxfkg"cfftgau"kphqt"ockvqp}

Network: Network6

Vjku"fkurnc{"rtqxfgu"vjg"cdknkv{"vq"xkgy"cpf"oqfkh{"vjg"KRx8"pgvyqtm"ugvvpku"Vjg"rctcogvgtu"kpwnwfg"J{pcoke"Jquv"EqpLiwtcvkqp"Rtqvqeqn"FER+"KR"cfftgau."icvgyc{.pgv"ocum"cpf"fq"ockp"pcog"ugtxgt"FPU+"ugvvpku"Gpcdnng"FER"vq"cnmqy"cwvq"ocvke"u{uvgo"eqpLiwtcvkqp"qh"vjg"pgvyqtm"kpvgthceg"Yjgp"FER"ku"fkucdnng"vjg"wugt"owuv"rtqxfkg"cfftgau"kphqt"ockvqp}

Network: MAC Address (MAC\_Addr)

Vjku"fkurnc{"rtqxfgu"vjg"ogfkc"ceeguu"eqpvtqn"OCE+"cfftgau"htq"dqvj"pgvyqtm"rqtvu"fu1"cpf"fu2}

Network: REBOOT

Vjku"ku"cy{"vq"tgdaqv"vjg"Uqpqoc"cpf"ku"pgeguuct{"chvgt{"qwxg"Łpkujgf"eqpLiwtkpi"vjg"pgvyqtm"rctcogvgtu"Wpkn{"qw"fq"vjku."vjg"pgvyqtm"rctcogvgtu"vjcv"ctg"ujqyp"ykndg"vjg"cevkxg"ugvvpku."PQV"vjg"pgy"ugvvpku"Vjg"pgy"ugvvpku"ykndgeqog"cevkxg"chvgt{"qw"tgdaqv}

NTP Menu

Vjg"PVR"Ogpw"ku"ugngevgf"htqo"vjg"Ockp"Ogpw"cpf"rtqxfgu"ceeguu"vq"vjg"Uvcvwu."KIQ"Uvcvkukcu"cpf"Ugvr"fkurnc{"u"fguetkdg"dnqy<

NTP: Status

Vjku"fkurnc{"rtqxfgu"kphqt"ockvqp"cuuqekcvgf"ykvj"vjg"PVR"Uwdu{uvgo}

Uvtcvwo< Vjku"uvtcvwo"Łgnf"jcu"vjtggrquukdnng"xcnwgw<  
 " " Uvtcvwo"3< Vjg"ugtxgt"ku"hwmm{"u{pejtqpk|gf"cpf"ceewtcvg}  
 " " Uvtcvwo"4< Vjg"ugtxgt"ku"u{pejtqpk|gf"vq"Uvtcvwo"3"ugtxgt  
 " " Uvtcvwo"z< Vjg"ugtxgt"ku"u{pejtqpk|gf"vq"Uvtcvwo"z/3"ugtxgt  
 " " Uvtcvwo"38< Vjg"ugtxgt"ku"wpu{pejtqpk|gf"0"PVRENKGPV"ykndpqv"wug"Uvtcvwo"38  
 " " " " "ugtxgt  
 Uqwtg< Vjg"u{pejtqpk|cvkqp"uqwtg"ku"pcogf"jgtg"0"htq"vjg"Uqpqoc"IRU"vjg"uqwtg"ku"IRU.  
 " " KR"cfftgau"qh"wrvtgc"uqwtg."qt"pqpg}

Qhhugv< Vjg"PVR"qhhugv"kpfkcevgu"vjg"ceewtce{"qh"vjg"PVR"u{uvgo"enqem"tgnckvkg"vq"vjg"IRU  
 " " Uwdu{uvgo"enqem"0"Kpkvcnn{"kh"vjg"qhhugv"dgvyggp"vjg"PVR"u{uvgo"enqem"cpf"vjg"IRU  
 " " Uwdu{uvgo"enqem"ku"nctig"vjg"fkurnc{"yknd"kpfkcev"ōpq"cxkncdnng"0"Chvgt"vjg"IRU  
 " " Uwdu{uvgo"nqemu."vjg"PVR"enqem"yknd"u{pejtqpk|gf"vq"vjg"IRU"Uwdu{uvgo"0"Qpeg"  
 " " u{pejtqpk|cvkqp"ku"eqo"rngvg."vjg"v{rkecn"qhhugvu"yknd"tcpig"qxgt"cr"rtqzk"ocvgn{"  
 " " -1/"3"oketqgeqpf}

NK"Dkvu< Ujgyu"vjg"uvcvwu"qh"vjg"ngcr"kpfkcevqt"dkvu"cu"ugpv"d{"vjg"Uqpqoc"vkog"ugtxgt"vq"vjg  
 " " enkgpvu"kp"vjg"PVR"tgrn{"rcengvu"0"Ngcr"ugeqpfu"qewt"cdqvw"gxgt{"3 "vq"5"{gctu"0"  
 " " Rquukdnng"kpfkcevqt"xcnwgw"ctg<

```
" " 22<" " Pqt o cn."hqemgf"qrgtcvkqp0
" " 23<" " Ngcr"ugeqpf"kpugtkqp"y knn"qeewt"chvgt"45<7 ; <7 ; "WVE0
" " 33<" " Hcwnv0""Wpu {pej tqpk |gf"uvcvg0
```

NTP: I/O Statistics (I/O\_Stats)

```
Vjku"fkurnc {"ujqyu"uq o g"mg {"kphqt o cvkqp"tgi ctfkpi "vjg"qrgtcvkqp"qh"vjg"PVR"fcg o qp0""Vjg"kphqt o c/
vkqp"kpenwfgu"vjg"vk o g"ukpeg"tgugv"cpf"vjg"eqwpu"qh"tgegxgf."ugpv"cpf"ftqr rfg"rcemgvu."cpf"vjg"ugpv"
rcemgv"tcvg0
```

NTP: Setup

```
Vjku"fkurnc {"rtqxfgu"ceeguu"vq"vjg"PVR"dtqcfecuv"cpf" o wnvkecuv"ugvvpki u"cpf"rtqxfgu" {qw"ykvj" c"
eqpxgpkgpv" o gcpu"qh"ejgemkpi "vjg"ewtgpv"eqpŁi wtcvkqp"cpf"cnny u"nk o kvgf"ugvwr0"" [qw" o c {"cnuq"
rgthqt o "c" o qtg"eq o rngvg"dtqcfecuvl o wnvkecuv"eqpŁi wtcvkqp"xc" c"u fmo f u"qt" t t i"uguukqp"qt"vjg"aqecn"
TU/454"eqpuqng"wukpi "vjg"ouq d p o g j h"vwnkv {0""Vjku"vwnkv {"rtqxfgu" c" o qtg"ugewtg" o gcpu"qh"ugvwr"cpf"
uq"ku" o qtg"eq o rngvg0""Kv" y knn"cnny y" {qw"vq"ugngev"mg {u"cpf"kf g p v k h {"vtwugf"mg {u0""
```

```
Vjku"fkurnc {"y knn"kp f k e c v g"v j c v"v j g" o q f g"ku"dtqcfecuv6."dtqcfecuv8." o wnvkecuv6." o wnvkecuv8"qt"fkucdngf0""
Kv"cnny yu"KRx6"qt"KRx8"eqpŁi wtcvkqp"qh"gvjgt"dtqcfecuv"qt" o wnvkecuv" o q f g"ykvj"ugngevqp"qh"vjg"dtqcf/
ecuv"cf f t g u u ." o wnvkecuv"vk o g/vq/nxg"*VVN+"cpf"vtwugf"mg {"hqt" O F 7"cwvj g p v k e c v k p p 0""Vjg"dtqcfecuvl
o wnvkecuv" o q f g" o c {"cnuq"dg"fkucdngf0
```

```
Dtqcfecuv"Oqfg" Kp"vjku" o qfg"vjg"dtqcfecuv"cf f t g u u"ku"fkurnc {g f 0""Kh" O F 7"cwvj g p v k e c v k p p"ku"
" " " ugngevgf"vjg"vtwugf"mg {"pw o dgt" y knn"cnny"dg"fkurnc {g f 0
```

```
O w n v k e c u v " O q f g " V j g " o w n v k e c u v " c f f t g u u " o w u v " d g " 4 4 6 0 2 0 3 0 3 " q t " h h 2 7 < < 3 2 3 0 " " O w n v k e c u v " o c { " c n u q " w u g "
" " " O F 7 " c w v j g p v k e c v k p p 0 " " K h " u g n g e v g f . " v j g " v t w u g f " m g { " p w o d g t " y k n n " c n u q " d g " f k u r n c { g f 0
```

```
Rtguu"GFKV"vq"ejcpig"vjg"dtqcfecuvl o wnvkecuv"ugvvpki u0""Gcej"qh"vjg"gfkv"ykpfyu"jcu"jgnr"kphqt/
o cvkqp"cxckncdng"vq"i w k f g {"q w " v j t q w i j " v j g " u g v w r " r t q e g u u 0 " " P q v g " v j c v " e j c p i k p i " v j e " P V R " o w n v k e c u v l
dtqcfecuv"ugvvpki u" f q g u " p q v " v c m g " g h h g e v " w p v k n " v j g " u { u v g o " t g d q q v u 0 " V j g " p g y " r c t c o g v g t u " c t g " n q c f g f " v q " v j g "
p v r 0 e q p h " L n g " k p " v j g " l d q q v l g v e l " f k t g e v t { 0 " " Q p n { " v j g " d t q c f e c u v " n k p g " k p " v j g " p v r 0 e q p h " L n g " k u " o q f k L g f 0 " " V j g "
Ł p c n " f k u r n c { " k p " v j g " g f k v " u g s w g p e g " t g s w k t g u " e q p Ł t o c v k q p " q h " { q w t " k p v g p v " v q " e j c p i g " v j g " k p u v t w o g p v " u g v /
v k p i u 0 " " Q p e g " e q p Ł t o c v k q p " v c m g u " r n c e g . " v j g " k p u v t w o g p v " y k n n " t g d q q v 0
```

Optional PTP Menu

```
Vjg"RVR"Ogpw"ku"wugf"ht"eqpvtqn"cpf"uvcvwu"qh"vjg"RVRlKGGG/37 : : "qrvkqp0""Ugg"
ht" o qtg"kphqt o cvkqp0
```

Clock Menu

```
Vjg"Enqem"Ogpw"rtqxfgu"ceeguu"vq"vjg"rctc o gvgtu"tgncygf"vq"vk o gmgrkpi0""Vjgug"ctg"Vk o ga Oqfg."
Vk o g a \ q p g . " J q w t a O q f g . " c p f " F U V 0 " " V j g u g " f k u r n c { u " c t g " c n n " f g u e t k d g f " d g n q y 0 " "
```



## Clock: Time Mode

Vk o g" o q f g" f g L p g u" v j g" v k o g" h q t o c v" w u g f" h q t" v j g" h t q p v/ r c p g n" v k o g" f k u r n c { " c p f. " k h" k p u v c m n g f. " v j g" q r v k q p c n" V k o g" E q f g" q t" U g t k c n" V k o g" q w v r w v 0" " V j g" v k o g" o q f g" f q g u" p q v" c h h g e v" v j g" P V R" q w v r w v. " y j k e j" k u" c n y c { u" W V E 0" " R q u i k d n g" x c n w g u" h q t" v j g" v k o g" o q f g" c t g" I R U. " W V E. " c p f" N q e c n" v k o g 0" " I R U" v k o g" k u" f g t k x g f" h t q o" v j g" I R U" u c v g n k v g" u { u v g o 0" " W V E" k u" I R U" v k o g" o k p w u" v j g" e w t t g p v" n g c r" u g e q p f" e q t t g e v k p p 0" " N q e c n" v k o g" k u" W V E" r n w u" v k o g" | q p g" q h h u g v" c p f" F U V 0" " V j g" v k o g" | q p g" c p f" F U V" f k u r n c { u" c t g" f g u e t k d g f" d g n q y 0

## Clock: Time Zone

V j g" v k o g" | q p g" k u" w u g f" k p" e c n e w n c v k p i" v j g" e w t t g p v" N q e c n" v k o g" y j g p" v j g" v k o g" o q f g" k u" u g v" v q" N q e c n" \* u g g" v k o g" o q f g" c d q x g + 0" " R t g u u" v j g" G F K V" m g { " v q" e j c p i" v j g" x c n w g 0" " G p v g t" c" p g i" c v k x g" q h h u g v" h q t" v k o g" | q p g u" y g u v" q h" v j g" I t g g p y k e j" o g t k f k c p. " c p f" c" r q u i k v k x g" q h h u g v" h q t" v k o g" | q p g u" v q" v j g" g c u v 0" " K h" g p c d n g f. " F U V" y k n n" c f f" c p" c f f k v k q p c n" j q w t 0

## Clock: Hour Mode

J q w t" o q f g" c h h g e v u" v j g" h t q p v/ r c p g n" v k o g" f k u r n c { " c p f" k u" c e v k x g" q p n { " y j g p" v j g" v k o g" o q f g" k u" u g v" v q" N q e c n" v k o g 0" " J q w t u/ f k u r n c { " u g n e v k q p u" c t g" g k v j g t" 3 4/ j q w t u" h q t o c v" \* 3/ 3 4" j q w t u" y k v j" C O I R O" k p f k e c v t+ " q t" 4 6/ j q w t" h q t o c v" \* 2/ 4 5" j q w t u+ 0

## Clock: Daylight Saving Time (DST)

F U V" k u" w u g f" k p" e c n e w n c v k p i" v j g" e w t t g p v" N q e c n" v k o g" y j g p" v j g" v k o g" o q f g" k u" u g v" v q" N q e c n 0" " Y j g p" v j g" v k o g" o q f g" k u" N q e c n" v j k u" f k u r n c { " y k n n" c m n q y" { q w" v q" g p c d n g" q t" f k u c d n g" F U V" d { " r t g u k p i" G F K V 0" " K h" F U V" k u" f k u c d n g f" v j g p" c p { " r t g x k q w u n { " u g v" u v c t v" c p f" u v q r" v k o g u" y k n n" d g" k i" p q t g f 0" " K h" F U V" k u" g p c d n g f" v j g p" v j g" u v c t v" c p f" u v q r" v k o g u" e c p" d g" u g v" d { " r t g u u k p i" v j g" c t t q y" m g { u" v q" u e t q m n" c p f" v j g p" G P V G T 0" " F U V" k u" c e v k x g" y k v j k p" v j g" u v c t v/ u v q r" k p v g t x c n" c p f" c f f u" q p g" j q w t" v q" v j g" N q e c n" v k o g 0" " K h" F U V" k u" c e v k x g" v j g" f k u r n c { " y k n n" u j q y" c p" c e v k x g" k p f k e c v q t 0

## Display Setup

V j k u" f k u r n c { " k u" u g n g e v g f" h t q o" v j g" O c k p" O g p w" c p f" e q p v c k p u" r t c t o g v g t u" t g n c v g f" v q" v j g" h w p e v k q p k p i" q h" v j g" h t q p v/ r c p g n" f k u r n c { 0" " V j g t g" c t g" v y q" r t c t o g v g t u" / / " c p" k p v g p u k v { " u g v k p i" c p f" c" u e t g g p u c x g t" u g v k p i 0" " V j g" k p v g p u k v { " u g v k p i" c m n q y u" { q w" v q" u g v" v j g" d t k i" j v p g u u" n g x g n" q h" v j g" X H F 0" " F k u r n c { " k p v g p u k v { " t c p i" g u" h t q o" " 3 4" ' " v q" 3 2 2" ' 0" " V j g" u e t g g p u c x g t" e c r c d k n k v { " c m n q y u" { q w" v q" k p e t g c u g" v j g" w u c d n g" n k h g" q h" v j g" f k u r n c { " d g { q p f" v j g" t c v g f" 3 2 2. 2 2 2" j q w t u 0" " Y j g p" v j g" u e t g g p u c x g t" e c r c d k n k v { " k u" g p c d n g f. " v j g" k p v g p u k v { " y k n n" d g" t g f w e g f" v q" j c n h" q h" k v u" p q t o c n" q r g t c v k p i" k p v g p u k v { " y j g p" v j g" w p k v" j c u" p q v" f g v g e v g f" c" m g { r t g u u" h q t" q p g" j q w t 0" " R t g u u" G F K V" v q" o q f k h { " v j g" k p v g p u k v { " c p f" u e t g g p u c x g t" u g v k p i u 0

## Firmware

V j g" H k t o y c t g" f k u r n c { " k u" u g n g e v g f" h t q o" v j g" O c k p" O g p w" c p f" r t q x k f g u" x g t u k a p" k p h q t o c v k q p" h q t" v j g" c r/ r n k e c v k p p" u q h v y c t g" t w p p k p i" q p" v j g" I R U" U w d u { u v g o" c p f" v j g" N k p w z" U w d u { u v g o" \* t q q v" L n g" u { u v g o" c p f" m g t/ p g n+ 0" " V j g" u g t k c n" p w o d g t" q h" v j g" U q p q o c" k u" u j q y p" h q t" w p k v u" u j k r r g f" c h v g t" L w n { " 4 2 3 7 0" " H q t" w p k v u" u j k r r g f" r t k q t" v q" v j c v. " v j g" u g t k c n" p w o d g t" o w u v" d g" q d v c k p g f" h t q o" c" n c d g n" q p" v j g" t g c t/ r c p g n 0" " W u g" W R" c p f" F Q Y P" v q" v q i" i n g" d g v y g g p" v j g" k p h q t o c v k q p" y k p f q y u 0

### About

Vjg"Cdqww"fkurnc{"ku"ugngevgf"htqo"vjg"Ockp"Ogpw"cpf"rtqxkfgu"eqpvcev"kphqtocvkqp"hqt"GpfTwp"  
Vgejppqni kgu0"Vjg"ygdukyg"cpf"vqnn/htgg"rjqpg"pwodgt"ctg"nkuvgf0



Vjku"rcig"kpvgpvkqpcnn{"nghv"dncpm0





## Upgrade via the Console Port

```
kp"qtfgt"vq"wr itc f g" xkc" vjg" eqpuqng" rqtv" *pgvy qtm" qt" ugtkc n+ {qw" y knm" pggf" vq" Ltuv" fqy pncf" vjg" cr rtq/
rtkcv g" Lt o yctg" k o c i g" htq o "qwt" y gdukv g" Vjg" Uqp q o c" Lt o yctg" eqpukuvu" qh" ugxtca" fkhgtgpv" dkpct {
Lngu0" [qw" o c { "qpn { "pggf" qpg" qt" v y q" qh" vjg o 0" Vjg" t g x k u k q p" j k u v q t { "qp" qwt" y gdukv g" y knm" v g m n" {qw" y j k e j
Lngu" pggf" vq" dg" wr itc f g f 0" Vjg" y gdukv g" nkpm" ku <
```

```
" g p f t w p v g e j p q n q i k g u l e q o l u w r r q t v l u q h v y c t g / w r i t c f g u l u q p q o c / i r u
```

## Performing the Linux RFS Upgrade

### NOTE TO LINUX GEEKS

There are two FLASH disk partitions which hold the compressed Linux root file system images. These partitions are raw FLASH blocks, have no file system and may not be mounted. They are accessed through low-level device drivers. To protect the factory root file system from accidental erasure or over-writing, the upgrade utilities you will be using will only access the upgrade root file system partition. When performing an upgrade, you will be erasing and then copying the new image to this device.

```
Hktuv {qw" pggf" vq" fqy pncf" vjg" Nkpwz" THU" Lt o yctg" htq o "vjg" Gp f Twp" y gdukv g" vq" c" rnceg" qp" {qwt"
pgvy qtm" y j k e j "ku" ceeguukdng" vq" vjg" Uqp q o c 0" Vjg" nkpm" vq" vjg" Uqp q o c" wr itc f g" r c i g" ku" u j q y p" cdqxg 0"
```

### CAUTION

Some browsers will automatically unzip the file when downloading from the website. Please make sure that the downloaded file size matches what the website says it should be. Upgrading the partition with a too-large file size will cause problems.

### Transfer File to Sonoma

```
[qw" o c { "vtcpuhgt" vjg" Lng" vq" {qwt" Uqp q o c" wukpi" gkvjgt" guq" qt" t d d 0" Kh" {qw" ctg" wukpi" "guq" "vtcpuhgt" vjg"
rtgkxkwun { "fqy pncf g f" Lng" wukpi" "dkpct { "vtcpuhgt" o q f g" htq o "vjg" t g o q v g" j q u v" vq" v j k u" u r g e k L e" Lng" qp"
{qwt" Uqp q o c < " l v o r l t q q v h u 0 i / 0" Vjg" t q q v" Lng" u { u v g o "k o c i g" y knm" dg" pc o g f" y kv j" vjg" u q h v y c t g" r c t v" p w o /
dgt" cpf" xgtukqp" nkm g < " 8232/2287/222a50220i / 0" Y j g p" h q n n q y k p i" v j g" k p u v t w e v k q p u" d g n q y. "u w d u k v w v g" v j g"
pc o g" qh" vjg" c e v w c n" t q q v" Lng" u { u v g o "k o c i g" v j c v" {qw" ctg" k p u v c n n k p i" h q t" 8232/2287/222a50220i / 0" Kuuwg"
vjgug" eq o o c p f u" htq o "vjg" eqpuqng" qh" {qwt" Uqp q o c <
```

```
guq!sfnpu f`iptuA A A | r g t h q t o " h v r" n q i k p" q p" t g o q v g" j q u v c
cjo" " " " " } u g v" v t c p u h g t" o q f g" v q" d k p c t { ;
hfu!7121.1176.111`4/11/h{!0unq0sppugt/h{! }vtcpuhgt"vjg"ing;
rvjuAAA AAA AAA AAA AAA A A | e n q u g" v j g" h v r" u g u u k q p" c h v g t" v t c p u h g t A c
```

kh{qw"ctg"wukpi"tdα."{qw"oc{"qrgp"ceqo ocpf"ykpfaqy"qp"vjg"tg oqvq"eq o rwwgt"cpf"ugewtgn{"



## Recovering from a Failed RFS Upgrade

```
Vq"tguvqtg" {qwt"Uqpq o c"vq" c"dqqvcdng"uvcvg"wukpi"vjg"hcveqt {"tqqv"Łng"u {uvg o ." {qw" o wuv" wug"vjg"ugtkcn"
KlQ"rqtv"cpf"tgdqqv"vjg"Uqpq o c"d {e {enkpi"vjg"rqygt0""Tghgt"vq"
"ht"ugvwr"fgvcknu0""Yjgp" {qw"jcxg"eqppgevfg"
{qwt"vgt o kpcn"vq"vjg"ugtkcn"KlQ"rqtv."crrn {"rqygt"vq"vjg"Uqpq o c0
```

```
Rc {"enqug"cvvgpvkqp"vq"vjg"vgt o kpcn"ykpfaqy"y jkng"vjg"wpkv"ku"tgdqqv"kp i 0""Chvgt"vjg"Nkpwz"dqqvncfgt"
fkurnc {u"vjg" o guucig
```

```
Efgbvmu!lfsofm;!GBDUPSZ
```

```
Up!pwfssjef!boe!cppu!uif!VQHSBEF!wfstjpo!pg!uif!lfsofm-!
```

```
uzqf!VQHSBEF!xjuijo!6!tfdpoet
```

```
/////
```

```
Cppujoh!xjui!GBDUPSZ!Lfssofm
```

```
Efgbvmu!Sppu!Gjmf!Tztufn;!VQHSBEF
```

```
Up!pwfssjef!boe!cppu!uif!GBDUPSZ!wfstjpo!pg!uif!Sppu!Gjmf!Tztufn-!
```

```
uzqf!GBDUPSZ!xjuijo!6!tfdpoet
```

```
{qw" o wuv"dgi kp"v {rkpi"ohcevt {"ö"ykvj kp"Łxg"ugeqpfu"vq"ngv"vjg"dqqvncfgt"mpqy"vjcv" {qw"ctg"i qkp i"vq"
qxgttkfg"vjg"fghcwnv"tqqv"Łng"u {uvg o 0""Chvgt" {qw"j kv">gpvgt@""vjg"dqqvncfgt"y knn"dqqv"vjg"hcveqt {"tqqv"
Łng"u {uvg o 0""Ycvej"vjg"tguv"qh"vjg"dqqv"rtqegu"vq" o cmg"uwtg"vjcv" {qw"jcxg"uweeguuhwnn {"tgeqxgtgf0""Kh"
vjg"u {uvg o "dqqv"pqt o cnn {"vjgp" {qw"u j qwnf"tguqnxg"vjg"rtqdn g o u"ykvj"vjg"rtgxxkwu"tqqv"Łng"u {uvg o "
wri tcf g"cpf"tg/rghqt o "kv0
```

## Performing the Linux Kernel Upgrade

```
Hktuv {qw"pggf"vq"fqy pncf"vjg"Nkpwz"mgtpgn"Łt o yctg"htq o "vjg"GpfTwp"y gdukvg"vq" c"rnceg"qp" {qwt"
pgvy qtm"y jkej"ku"ceeguukdn g"vq"vjg"Uqpq o c0""Vjg"nkpm"vq"vjg"Uqpq o c"wri tcf g"rcig"ku"ujqyp"cdqxgl0""
```

## Transfer File to Sonoma

```
[qw" o c {"vtcpuhgt"vjg"Łng"vq" {qwt"Uqpq o c"wukpi" gkvjgt"guq"qt"tdq0""Kh" {qw"ctg"wukpi"guq."vtcpuhgt"vjg"
rtgxxkwun {"fqy pncf g"Łng"wukpi"dkpct {"vtcpuhgt" o qfg"htq o "vjg"tg o qvg"jqv"vq"vjku"urgekŁe"Łng"qp"
{qwt"Uqpq o c<"lv o rlmgtpgn0 i /0""Vjg"mgtpgn"ko cig"y knn"dg"pc o gf"ykvj" c"uqhvyctg"rctv"pw o dgt"nkmg ħ
```

**vqhsbeflfsfm**

Pgzv."wrfcvg"vjg"fgbcwv"Łng"u{uvgo"rctvkvqp"d{"kuwkp"vjku"eqo"ocpf"vq"}qwt"Uqppoc"eqpuqng<

**vqebuf1fsfmgbh!2**

[qw"ujqwnf"ugg"vjku"nkg"fkurnc{gf<

**Efgbvmu!Lfsfm!opx!tfu!up;!VQHSBEF**

Hkpcmn{."tgdqqv"vjg"u{uvgo"d{"kuwkp"vjku"eqo"ocpf"cv"vjg"ujgmn"rtqorv<

**sfcppu**

Yckv"cdqvw";2"ugeqpfu"hqt"vjg"u{uvgo"vq"ujwvfqyp"cpf"tgdqqv"Vjgp"nq"kp"vq"vjg"Uqppoc"wukpi"  
**ufmofu"qt"tti**0"Kh"cmnjcu"iqpg"ygm."{qw"ujqwnf"dg"cdng"vq"nq"kp"vjg"uwcn"yc{0" [qw"ecp"ejgem"vjg"  
twppki"mgtpgn"xgtukqp"cv"cp{"vkog"d{"kuwkp

**lfsfmwfstjpo**

yjkej"yknn"ecwug"vjg"mgtpgn"xgtukqp"oguucig"vq"dg"fkurnc{gf0

[qw"ecp"cnuq"ejgem"vq"ugg"yjkej"mgtpgn"kog"vjg"u{uvgo"ku"ewtgpvn{"dqqv"wpfgt"d{"kuwkp"vjku"  
eqo"ocpf"cv"vjg"ujgmn"rtqorv<

**tzt1fsfm**

Yjkej"ujqwnf"ecwug"vjku"vq"dg"rtkpvf"vq"vjg"eqpuqng<

**CPPUFE!LFSOFM!JNBHF!>!2!)Vqhsbef\***

Kh"uq."cpf{"qwt"wpkv"uggou"vq"dg"qrgtcvki"pqtocmn{"qw"jcxg"uweeguuhwn{"eqorngvf"vjg"mgtpgn"  
writcf"0"Kh{"qwt"wpkv"fqgu"pqv"dqv"wr"uweeguuhwn{"cpf{"qw"ctg"pqv"cdng"vq"**ufmofu"qt"tti**"kp"vq"vjg"  
u{uvgo"chvgt";2"ugeqpfu."vjgp"vjgtg"jcu"dggp"uqog"mkpf"qh"rtqdng"ykvj"vjg"mgtpgn"writcf"0"Kv"ku"  
rqukdng"vjcv"vjg"Łng"fqypnqcf"y"cu"eqttwrv"qt"vjcv{"qw"htiqv"vq"ugv{"qwt"**guq**"fqypnqcf"Łng"oqfg"  
vq"dkpct{"yjgp"fqypnqcf"vjg"Łng//gkvjgt"htqo"vjg"GpfTwp"Vgejpnqikgu"ygdukvg"qt"yjgp"vtcpuhgt/  
tkpi"kv"vq"vjg"Uqppoc0

Recovering from a Failed Kernel Upgrade

Vq"tguvqtg" {qwt" uqo O o

```
{qw"o wuv"dg ikp"v{ rkp i "öhcevqt{ö" ykv jkp"Łxg"ugeqp fu"vq"ngv"vjg"dqqvncf fgt"mpqy"vjcv"{qw"ctg"i qkp i"vq"
qxggtkf g"vjg"fg hcnv"mgtpgn0"Chvgt" {qw"jkv">gpvgt@"vjg"dqqvncf fgt"y knn"dqqv"vjg"hcevqt{ "mgtpgn0" Ycvej"
vjg"tguv"qh"vjg"dqqv"rtqeguu"vq" o cmg"uwtg"vjcv" {qw"jcxg"uweeguuhwmn{ "tgeqxgtgf0"Kh"vjg"u{uvg o"dqqvu"
pqt o cmm{"vjgp" {qw"ujqwnf"tguqnxg"vjg"rtqdn g ou" ykvj"vjg"rtgxxkwu"mgtpgn"wr i tcf g"cpf"tg/rgthqt o"kv0
```

### Performing the GPS Subsystem Upgrade

```
Hktuv{qw"pggf"vq"fqy pncf"vjg" IRU"Uwdu{uvg o"Łt o yctg"htq o"vjg"GpfTwp"y gdukvq"vq" c"rnceg"qp"
{qwt"pgvy qtm"y jkej"ku"ceeguukdn g"vq"vjg"Uqpq o c0"Vjgtg"ctg"vyq"fkhhgtgpv"xgtukqpu"qh"vjg" IRU"Uwd/
u{uvg o"Łt o yctg0"Ocmg"uwtg" {qw"fqy pncf"vjg"cr rtrtc w"Łt o yctg"Łng"*ugg"pqvg"dgnqy +0"Vjg"nkpm"
vq"vjg"Uqpq o c"wr i tcf g"rc ig"ku"ujqyp"cdqxg0"
```

#### NOTE

Before proceeding, use the `hqtwfstjpo` command to check the firmware number of your GPS Subsystem. You will see a response similar to this:

```
G0X!7121.1182.111!Wfs!2/11!.!GQHB!7131.1123.111!Wfs!12!.!KBO!26!28;14;38!3127
Or
G0X!7121.1187.111!Wfs!3/31!.!GQHB!7131.1127.111!Wfs!13!.!BQS!14!22;6; ;26!3127
```

You will need to upgrade using the same firmware number    Bethe fi

rmw\_





[qw" o c {"vtcpuhgt"vjg"Łng"vq" { qwt"Uqpq o c"wukpi "gkvjgt"guq"qt"tdq0""Kh" {qw"ctg"wukpi "guq!vq"rgthqt o "  
vjg"wr i tcfg."vtcpuhgt"vjg"rtgkqwun {"fypnqcfgf"Łng"wukpi "dkpctf



**! bqspqpt!ouq**

Vjg"tgngxcpv"cxckncdng" o cp"rcigu"ctg"ujqyp<

**! ouq!\^!!!!!!!!!!!!!!!!!!!!)2\*!!.!lfzhfo!.!Dsfbuf!b!OUQ!iptu!lfz**  
**! ouqe!\^!!!!!!!!!!!!!!!!!!!!)2\*!!.!OUQ!ebfnpo!qsphsbn**  
**! ouqed!\^!!!!!!!!!!!!!!!!!!!!)2\*!!.!wfoeps.tqfdjgjd!OUQ!rvfsz!qsphsbn**  
**! ouqr!\^!!!!!!!!!!!!!!!!!!!!)2\*!!.!tuboebse!OUQ!rvfsz!qsphsbn**  
**! ouqtonqe!\^!!!!!!!!!!!!!!!!!!!!)2\*!!.!OUQ!TONQ!NJC!bhfou**  
**! touq!\^!!!!!!!!!!!!!!!!!!!!)2\*!!.!tuboebse!TOUQ!qsphsbn**

Pqy"{qw"ecp"kuuwg"kuuwg"nbo"eq o o cpfu"qp"gej"qh"vjgug" o cp"rcigu"vq"Łpf"y jcv"{qw"ctg"nqmkpi"hqt0

### Change Password

Vjku"eq o o cpf"ku"wgf"vq"ejcpi"vjg"rcuu y qtf"hqt"vjg"wg"vjcv"{qw"ctg"nqi igf"kp"cu0"Kv"chgevu"vjg" ugtkc"rqtv."UUJ."Vgnpgv"cpf"JVVRU0"

" **qbttxe**  
"

### List Active Processes

Vjku"eq o o cpf"fkurnc{u"cn"cevkxg"rtqeguugu"twppkpi"kp"vjg"u{uvgo0

" **qt!.f**

### NTP Monitoring and Troubleshooting

Vjg"hqmqy kpi"eq o o cpf"fkurnc{u"y jkej"PVR"enkpvu"ctg"tgcejkpi"vjg"PVR"fcgo qp"twppkpi"qp"vjg" Uqpq o c0"Kv"y knn"pqv"vt{"vq"nqqm"wr"j quv"pc o gu<

" **ouqr!.o!.d!nsvmjtu**

C"wughwn"eq o o cpf"hqt"swgt{kpi"PVR"uvcwv"ku"vjg"hqmqy kpi<

" **ouqr!.qffst**

Vq"swgt{"c"tgo qvg"vk o g"ugtxgt"\*kh"vjg"tgo qvg"vk o gugtxgt"y knn"ceegr"vjg"swgt{+}{v}{rg<

" **ouqr!.qffst!=iptuobnf@**

C"vcdng"qh"kpht o cvkqp"y knn"dg"fkurnc{gf0"Hqt"fgvcknu"qp"y jcv"gej"qh"vjg"vcdng"eqnw o pu" o gcpu"v}{rg<

" **nbo!ouqr**

Vq"ugg"y jcv"xgtukqp"qh"vjg"PVR"fcgo qp."pvr f."ku"qrgtcvkpi"v}{rg<

" **ouqe!..wfstjpo**



## Text Editors

```
Vjgtg"ctg"vjtg"vgzv"gfkvqtu"tgukf"gpv"qp"vjg"Uqpqoc"Łng"u{uvgo<"fejū.kpf"cpf"fmwjt0""Cnn"qh"vjgug"
oc{"dg"wughwn"y jgp"pggfkpi"vq"gfku"u{uvgo"eqpŁiwtcvkq"Łngu"qt"vq"xkgy"cpf"ugcte j"ykvj"kp"u{uvgo"
nqi"Łngu0"
```

```
fejū" ku"cxgt{"uko"rng"gfkvqt"ykvj"Yqtfuvt"mg{"eqo"ocpfu"vjcv"ycu"qtki"kpenn{"fgxgnqrgf"htq"
gzvtg"ogn{"og"oqt{/nk"okvgf"gpxtqpo"gpvu."uwej"cu"lqrr{"dqv"fkumu"cpf"godgffgf"Nkpwz"cr"rnkpegu0"
Y jgp"GpfTwp"Vgej"pqni"kgu0"Łtuv"i"gpgtcvkq"Nkpwz/dcugf"godgffgf"pgv"yqtm"vko"g"ugt"xtgu"ygtg"kp/
vtqfwegf."vjg{"hgn"kpq"vjku"ecvgi"qt{"cpf"vjg"fejū"vgzv"gfkvqt"ycu"cr"rtqr"tkcvgl0""Pqy"kv"ku"kpenn"fgf"qp"
vjg"Uqpqoc"Łng"u{uvgo"htq"ngice{"tgc"uqpu."ukpeg"kv"jcu"dggp"vjg"fgbcwn"gfkvqt"htq"cnm"Łtuv"cpf"ugeqpf"
i"gpgtcvkq"GpfTwp"Vgej"pqni"kgu"rtqf"wevu0""C"ocp"rci"qht"fejū"ku"tgukf"gpv"qp"vjg"u{uvgo"0""Y jgp"
kv"ku"Łtuv"uvctvgf."cpf"{"qw"fkf"pqv"ixg"kv"c"Łng"pc"og"vq"gfku"qp"vjg"eqo"ocpf"nkpg."kv"ujqyu"cu"uvctv/wr"
uetggp"ykvj"kvu"eqo"ocpf"u{pvcz."Dwv"qpeg"{"qw"jcxg"qrgpgf"c"Łng"vq"gfku."qpnkpg"jgnr"ku"pqv"cxckncdng0"
kv"ku"uvctvgf"d{"kuwkp"i"vjg"eqo"ocpf"fejū!\gjm f .up .fejū^."qrvkqpcnn{"ykvj"c"Łng"pc"og"vq"gfku0"
```

```
kpf" ku"vjg"oqfgtp"tgrncego"gpv"htq"fejū"qp"vjg"Uqpqoc0""Kv"ku"c"hwnn/hgcwvtgf"gfkvqt"ykvj"
u{pvcz"jki"jnkij"vkpi"cpf"ku"cnuq"dcugf"qp"vjg"Yqtfuvt"eqo"ocpfu0""Kv"ku"wgut"htkqpf"n{"ykvj"gcu{"vq"Łpf"
jgnr"htq"kvu"mg{"eqo"ocpfu."cpf"eqo"rngvg"ocp"rci"qf"qew"ogpvcvkq"p0""Kv"ku"vjg"tgeqo"ogpfgf"gfkvqt"htq"
cnm"rwt"rqug"wg"kp"eqpŁiwtkpi"cpf"o"qpkvqtkpi"vjg"Uqpqoc"vko"g"ugt"xtg0""Kv"ku"uvctvgf"d{"uko"rn{"kuwkp"i"
vjg"eqo"ocpf"kp f ! \gjm f .up .fejū^."qrvkqpcnn{"ykvj"c"Łng"pc"og"vq"gfku0"
```

```
fmwjt" ku"c"hwnn/hgcwvtgf"wj"enqpg"y"jkej"ku"rtqxf"fgf"kp"vjg"Uqpqoc"Łng"u{uvgo"htq"o"cuqej"kvke""
Wpkz"fkj"ctfu0""Kv"ku"pqv"vjg"ngcu"dkv"wgut"htkqpf"n{"vq"cp{"qpg"ncemkpi"gzr"gtkqpeg"ykvj"vgzv"o"qfg"cr/
rnkecvkqpu0""Kh"{"qw"fqpv"mpqy"y"jcv"wj"ku."cxqkf"wkupi"vjku"gfkvqt#"Kv"ku"uvctvgf"d{"uko"rn{"kuwkp"i"vjg"
eqo"ocpf"wj!\gjm f .up .fejū^."qrvkqpcnn{"ykvj"c"Łng"pc"og"vq"gfku0"
```

## Change Log-In Banners

```
Vjgtg"ctg"vjtg"fkhhgtgpv"nqi/kp"dcppgtu"kp"vjg"Uqpqoc"/"vjg"ugt"kc"n"rqtv"dcppgt."vjg"Vgnpgv"dcppgt."cpf"
vjg"UUJ"dcppgt0""[qw"owuv"dg"nqigf"kp"cu"vjg"ōtqqvō"wgut"kp"qtf"gt"vq"gfku"vjg"telnqecn"Łng"cpf"ejcpi"g"
vjg"nqi/kp"dcppgtu0""Rgthqt"o"vjg"hqmqy"kp i <
```

```
" fejū!0fud0sd/e0sd/mpdbm
```

```
Ejcpig"vjg"dcppgtu"cu"cr"rtqr"tkcvgl0""Chvgt"ucxkpi"vjg"Łng."eqr{"kv"vq"ldqqvlgve"nkmg"vjku<
```

```
" dq! .q!0fud0sd/e0sd/mpdbm!0cppu0fud0sd/e
```

```
Vjgp"tgdqq"htq"{"qwt"ejcpi"gu"vq"vcmg"ghhge"v0
```

```
""
```









## PTP Software License

Vjg"RVRlKGGG/37: : "qrvkqp"cu"ko rno gpgvf"kp"vjg"Uqpqoc"ku"eqxgtgf"d{"rcvgpvu"cpf"eqr{tkijvu0  
Hqt"rcvgpvu"vjcv"rgtvckp"vq"vjg"Uvf"Pq"37: : "ugg"vjg"KGGG"Uvcpfctfu"Cuuqekcvkqp0

Kphqtocvkqp"cdqww"vjg"RVR"Rtqlgev."ngf"d{"Mgpfcmm"Eqttgmm."ecp"dg"hqwpf"cv<""  
rvrfl0uqwteghqti g0pgv

Vjg"fkuvtkdwwkqp"cpf"wucig"qh"vjg"RVR"uqhvycg"ku"cnmqygf."cu"nqpi"cu"vjg"hqnnqykipi"eqr{tkijv"pqvkeg"  
ku"kpenwfgf"kp"qwt"fqewogpvcvkqp0"Vjg"eqr{tkijv"pqvkeg"crnkgu"vq"cnm"Łngu"ykej"eqorqug"vjg"RVRf0"  
Vjku"pqvkeg"crnkgu"cu"kh"vjg"vgzv"ycu"gzrnkekn{"kpenwfgf"kp"gcej"Łng0

Eqr{tkijv"\*e+4227/422: "Mgpfcmm"Eqttgmm."CkfcP"Yknkcou

Rgtokkuqkp"vq"wug."eqr{. "oqfkh{"cpflqt"fkuvtkdww"vjku"uqhvycg"hqt"cp{"rwtreq"ykvj"qt"ykvjqw"hg"  
ku"jgtgd{"itcpvgf."rtqkfgf"vjcv"vjg"cdqxcg"eqr{tkijv"pqvkeg"cpf"vjku"rgtokkuqkp"pqvkeg"crngct"kp"cnm"  
eqrkgu0

VJG"UQHVYCTG"KU"RTQXKFGF"õ \_ O q # U / n O



## GPS Antenna Kit

Vjg"vk o g"ugtxgt"v { rkecn { "ujkru" ykvj "cp" qrvkqpcn" IRU" Cpvppc" Mk v" y jke j "kpenwfgu" 72" hggv" \*37" o gvtu+ " qh" cpvgppc" ecdng" " Vjku" c o qwpv" qh" ecdng" ku" uwhŁekgpv" hqt" vjg" o clqtkv { "qh" IRU" cpvgppc" kpuvcnncvkqu" " Nqpi gt" ecdng" twpu" ecp" cnuq" dg" ceeq o o qfcvgf" " Dgnqy" ku" c" nkuv" qh" vjg" kvg o u" kp" c" v { rkecn" IRU" Cpvppc" Mk v<

É" IRU" Cpvppc

É" Oqwpvki "Rkrg

É" Jqug" Enc o ru

É" 72" hggv" qh" T I / 7 ; W \* Dgnfgp" ; 326+ " EcdnglVPE" O cng

kp" Lwpg" 4239. " GpfTwp" e jcpigf" vjg" IRU" cpvgppc" o qfgn" vjcv" ujkrgf" ykvj" vjg" vk o g" ugtxgt" " C" ftcy kpi" qh" vjg" IRU" tqqh/vqr" kpuvcnncvkq" hqt" vjg" v y q" fkhgtgpv" cpvgppc" ku" ujqyp" cv" vjg" gpf" qh" vjku" crgpfkz" kp" Hkiwtgu" 3C" cpf" 3D" " Eq o rnvng" IRU" Tqqh/Vqr" kpuvcnncvkq" I wkfgu" ctg" jgtg<"

Hqt" cpvgppc" ujkrgf" chvt" Oc { 4239<

" gpf" twpvge jpqni kguleq o lrfhl7272/2239/2220r fh

Hqt" cpvgppc" ujkrgf" dghqtg" Lwpg" 4239<

" gpf" twpvge jpqni kguleq o lrfhl7272/2237/2220r fh

## About Coax Cable

Vjg" IRU" uki pcn" htsgwpe { "ku" eqpukfgtgf" vq" dg" kp" vjg" o ketqycxg" tcpig" cpf" ku" jki jn { "chhgevgf" d { " k o r g f c p e g" o k u o c v e j g u" c p f" f k u e q v k p w k v k u" k p" v j g" v t c p u o k u u k q p" e c d n g u" " C n n" T H" e q c z" e c d n g u" j c x g" c" o k p k o w o" d g p f" t c f k w u" " k p" q t f g t" v q" r t g x g p v" f c o c i g. " e c d n g" u j q w n f" p q v" d g" d g p v" k p v q" v k i j v" e w t x g u" " K v" k u" e t k v k e c n n { " k o r q t v c p v" f w t k p i" k p u v c n n c v k q p" v j c v" m k p m u" c t g" p q v" c n n q y g f" v q" h q t o" k p" v j g" e c d n g" " K h" T H" e q c z" e c d n g" k u" d g p v" d g { q p f" k v u" o k p k o w o" d g p f" t c f k w u" v j g p" f c o c i g" v q" v j g" k p p g t" e q p u v t w e v k q p" q h" v j g" e c d n g" o c { " t g u w n v" " V j k u" e c p" n g c f" v q" o w e j" j k i j g t" n g x g n u" q h" n q u u" c p f" c" p q p" h w p e v k q p k p i" IRU" t g e g k x g t" " "

Uk o knctn { . " e c t g" u j q w n f" d g" v c m g p" v q" g p u w t g" v j c v" v j g" e c d n g" k u" p q v" e t w u j g f. " q t" n k m g n { " v q" d g" e t w u j g f" n c v g t" " K h" v j g" T H" e q c z" e c d n g" f q g u" u w h g t" v j k u" m k p f" q h" f c o c i g. " v j g p" v j g" f k o g p u k q p u" q h" v j g" e c d n g" y k n n" d g" e j c p i g f" c p f" k v" y k n n" p q v" o c k p v c k p" k v u" e j c t c e v g t k u v k e" k o r g f c p e g" " C i c k p. " v j k u" e c p" t g u w n v" k p" c" p q p" h w p e v k q p k p i" IRU" t g e g k x g t" " "

Rngcug" mggr" vjg" cdqxs" r tgecvwkqu" kp" o kpf" y jgp { qw" kpuvcn" vjg" IRU" ecdng" " Kv" ujqwnf" pqv" dg" vtgcvgf" nkmg" c" i c t f g p" j q u g" q t" c" r q y g t" g z v g p u k q p" e q t f o

## Long Cable Runs

Oquv" IRU" Vk o g" Ugtxgtu" ctg" kpuvcnngf" ykvj" qpn { "72" hggv" \*37" o gvtu+ " qh" cpvgppc" ecdng" " Jqy gxtg. " vjgtg" ctg" o cp { "ektew o uvcpegu" y jgtg" 72" hggv" ku" kpcfgswcvgl" GpfTwp" ecp" ceeq o o qfcvg" c" ecdng" ngp i v j" qh" w r" vq" 3222" hggv" wukpi" c" eq o dkpevkq" qh" nq y / nquu" ecdng" cpf" r t g c o r n k Ł g t u o





Using Three Preamplifiers

Kpucvncvkqp"htq"qpg"qt"v"y"q"rtgc o rnkŁgtu"ku"uk o r ng0""Dwv"vjg"rj {ukecn"nc{qww"qh"vj tgg"rtgc o rnkŁgtu"ku" etkvecn0""Rtgc o rnkŁgtu"ujqwnf"dg"kp"cu"uvtcki j"v"nkpg"fg rctvki"htq o "vjg"dqvq o "qh"vjg"cpvgppc"uq"vjcv" cp{"ngcmc ig"htq o "vjg"fqy pngcf"ecdng"ku"cu"ht"htq o "vjg"cpvgppc"cu"rquukdng0""C"rqukvkg"hg gfdcem"rcv j" ecp"qeewt"htq o "vjg"qwwrww"qh"vjg"ncuv"rtg/c o r."vj tqw i j"vjg"ecdng"ujkgnf"cpf"dcem"wr"vq"vjg"cpvgppc0"" Vjku"jki jnki jvu"vjg"ko rqtvcpeg"qh"rtqrgtn{"eqpuvtwevgf"ecdng"vgt o kpcvkqpu"cpf"fqwdng"ujkgnfgf"ecdng0""

Hqt"kpucvncvkqpu"wukpi"vj tgg"rtgc o ru."yg"tgeq o o gpf"vjcv"vjg"ncuv"rtg/c o r"dg"nqecvfg"cu"ht"cu"ku" r tcevecn"htq o "vjg"cpvgppc0""Vjku"ku"dgecwug"vjg"cpvgppc"cpf"vj tgg"rtgc o rnkŁgtu"y knm"j cxg" o qtg"vj cp" 322"fd"qh"i ckp."kpetgcukpi"vjg"nkmgkjqqf"vjcv"gpqw i j"ngcmc ig"htq o "vjg"ecdng"ecp"ecwug"otqwpf/vjg/ yqtnfö"hg gfdcem"vq"vjg"cpvgppc"cpf"ugv"wr"quekncvkqp0"" Jgtg"ku"vjg"uw i i guvgf"eqpŁ i wtcvkqp"htq"cp" cpvgppc"kpucvncvkqp"y kvj"vj tgg"rtgc o rnkŁgtu<

- " IRU"cpvgppc
- " Qpg"hqqv"ecdng
- " Rtgc o rnkŁgt
- " Qpg"hqqv"ecdng
- " Rtgc o rnkŁgt
- " Wr"vq"3.222"hg gv"\*527" o gvgtu+"ecdng
- " Rtgc o rnkŁgt
- " Qpg"hqqv"ecdng
- " Uppq o c"IRU"Vk o g"Ugtxgt

Other Accessories

Lightning Arrestor

Cnki jvvpki"cttguvqt"jgnru"rtqvgevf{qwt"IRU"kpucvncvkqp"htq o "fc o c ig"fwg"vq"nki jvvpki"uvtkngu0""Kv"ku" fguki pgf"vq"rcuu"vjg"FE"xqnc ig"vjcv"ku"pggfgf"vq"rqygt"vjg"cpvgppc"cpflqt"rtgc o ru"y kvj qw"fg i tcf/ kpi"vjg"IRU"uk i pcn0""Kv"ku"kpucvncvkqp"dgvy ggp"vjg"cpvgppc"cpf"vjg"tgekxgt"y jgtg"vjg"ecdng"gpvgtu"vjg" dwknfkpi."pgct"cp"gctvj/i tqwpf0"" [qw" o wuv"dqpf"vjg"nki jvvpki"cttguvqt"vq"vjg"gctvj/i tqwpf0""

Signal Splitters

Uki pcn"urnkvgtu"ctg"wugf"y jgp"vyq"vk o g"ugtxgtu"ctg"ujctki"qpg"cpvgppc"kpucvncvkqp0""Vjg"u o ctv"IRU" Urnkvtg"uwr rnkfg" d{"GpfTwp"ku"c"qpg/kprww."vyq/qwwrww"fgxkeg0""Kp"vjg"pqto c n"eqpŁ i wtcvkqp."qpg"qh" vjg"urnkvgt"TH"qwwrww"\*L3+"rcuugu"FE"htq o "vjg"eqppgevgf"IRU"Tgekxgt"vj tqw i j"vjg"urnkvgt"vq"vjg" cpvgppc."cnnq y kpi"vjg"IRU"Tgekxgt"vq"rqygt"dqvj"vjg"cpvgppc"cpf"vjg"urnkvgt"c o rnkŁgt0""Vjg"qvjgt" TH"qwwrww"\*L4+"ku"FE"nqcf"y kvj"c"422/qj o "tgukuvqt"vq"uk o wncvg"vjg"cpvgppc"ewttgvp"ftc y0"

Y jgp"ugngevki"cpf"kpucvncvkpi"cu"uk i pcn"urnkvgt"mggr"vjgug"rqkvu"kp" o kpf<

30""Vjg"urnkvgt" o wuv"dg"FE/dnqemgf"qp"qpg"ng i 0""Vjg"IRU"Tgekxgtu"kp"dqvj"vk o g"ugtxgtu"qwwrww" 7"XFE"wr"vjg"eqcz"vq"rqygt"vjg"IRU"cpvgppc"dwknv/kp"rtgc o r0"" [qw" o wuv"pqv"eqppgevg"vjgug"vyq" r qygt"uqwtegu"vqi gvjgt0

40""Kv"ku"fguktdng"vjcv"vjg"FE/dnqemgf"ng i "jcu"cu"FE"nqcf"tgukuvqt"vq"uk o wncvg"cu"IRU"cpvgppc"nqcf0"" Vjku"y c{"{qw"y knm"pqv"i gv"cu"hcnu"cnct o "htq o "vjg"IRU"Tgekxgtu"cpvgppc"nqcf"ugpuqt0"" Jqy gxtg."vjg"



2832/222;/223	Mkv"ykvj"72ø*37 o+"ecdng	84"pcpqugeqpfu	Dgnfgp";326."3046"pulhqqv
2822/2235/272	72ø*37 o+"ecdng	84"pcpqugeqpfu	Dgnfgp";326."3046"pulhqqv
2822/2235/322	322ø*52 o+"ecdng	346"pcpqugeqpfu	Dgnfgp";326."3046"pulhqqv
2822/2235/372	372ø*68 o+"ecdng	<b>Dø: 8"pcpqugeqpfu</b>	Dgnfgp";326."3046"pulhqqv
2822/2235/422	422ø*83 o+"ecdng	46"pcpqugeqpfu	Dgnfgp";326."3046"pulhqqv
2822/2235/472	472ø*98 o+"ecdng	532"pcpqugeqpfu	Dgnfgp";326."3046"pulhqqv
2822/2282/:22	:22ø*466 o+"ecdng	;4"pcpqugeqpfu	Dgnfgp"3727C."3046"pulhqqv
2822/2282/C22	3222ø*526 o+"ecdng	3462"pcpqugeqpfu	Dgnfgp"3727C."3046"pulhqqv
572;/2223/222	I/NPC4	42"pcpqugeqpfu	Ügg"fgxkeg"ncdgn"ht"gzcev"fgnc{0
6233/2224/222	I/NPC4"Mkv" *ykv4		



Tgeqt f"vjg" rqukvkqp"cpf"vjgp" ocmg"cp{"cflwuv o gpvu"vq"vjg"jgkijv"vcv" okijv"dg"pgeguuct{"kh"vjg"  
cpvgppc"ku"kpucmgf"kp"cjki j/tkug"dwknfkpi0""Kprwv"kv"vq"vjg"Uqpq o c"xkc"vjg"t.fuhqtsfgqpt

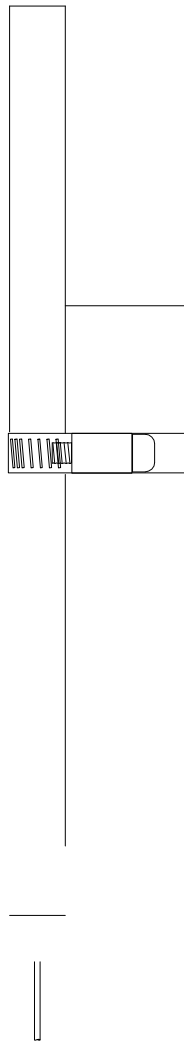

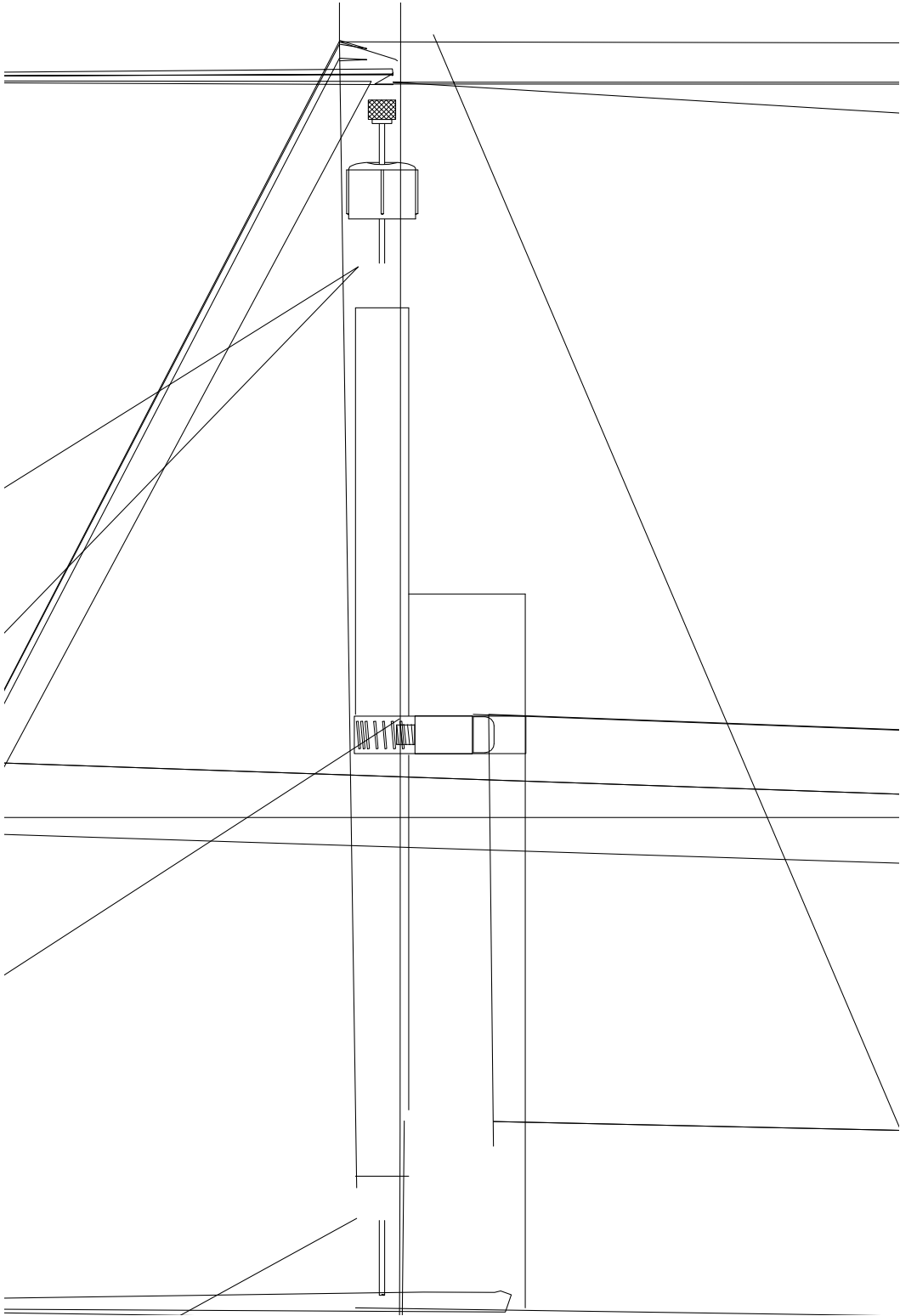

FIGURE 1B - GPS ANTENNA ROOFTOP MOUNTING GUIDELINES  
(SHIPPED BEFORE JUNE 2017)





Vjku"rcig"kpvgpvkqpcnn{"nghv"dncpm0







Vjku"hcwnv"kpfkcygu"vjcv"vjg"IRU"Uwdu{uvgo"ku"wpcdng"vq"eqpŁiwtg"vjg"HRIC0"Vjku"ku"c"hcvcn"hcwnv0"  
Rngcug"eqpvcev"GpfTwp"Ewuvqogt"Uwr rqtv0

À

Vjku"hcwnv"kpfkcygu"vjcv"vjg"IRU"Uwdu{uvgo"ku"wpcdng"vq"xgkth{"c"ytkvg"vq"vjg"HNCUJ"pqp/xqncvknq"  
rctcogvt"uvqtcig"ctgc0"Vjku"ujqwnq "vjg" nVjku wd #

Receiver Fault Definitions

Vjg"hqmq y kpi "hcwnv" rgtvckp"vq"vjg"GpfTwp" IRU"Tgegkxgt"\*ugg"  
 +0""Uppq o c"dg i cp"ujkr r kpi" ykvj"vjgug"tgegkxgtu"kp"Lwpg"42390

Y jgp" c"hcwnv"qp"vjg"GpfTwp" IRU"Tgegkxgt" qeewtu."vjg"u { uvgo "hcwnv"kp fkecvqt"TEXH" y knn"ujqy "hcwnv"  
 cpf"vjg"Cnct o "NGF" y knn"nki jv0"" [qw"ecp"ugg" y jkej "hcwnv"ku"vjg" rtdng o "d { "wukpi "vjg" **gbvmutubu**"eq o /  
 o cpl0""Dngy "ctg" fgvcknu"cdqvw" gcej "hcwnv"kp fkecvqt0

Vjku"hcwnv"kp fkecvgu"vjcv"vjg" FCE" hqt"vjg" quekncvqt" jcu"tgcejgf" gkvjgt"vjg" jki j "qt"nqy "cnct o "nk o kv"  
 y jkng"nqemgf"vq"vjg" IRU"uk i pcn0""Wpngu"vjg"wpkv"ku"dgkpi "uwlgevgf"vq"qww/qh/urgekŁecvkqp"gp xktqp/  
 o gpcn"eqpfkvkqpu."vjku" y qwnf"kp fkecvg"vjcv"vjg" quekncvqt"htgswgpe { "jcu" ftkhvf"pgct"vq"vjg" gpf"qh"nkhg"  
 tgi kqp0""Vjku"ujqwnf"pqt o cnn { "qpn { "qeewt"chvgt"cv"ngcu"v"vgp" { gctu"qh"qrgtcvkqp0""Vjg"wpkv" y knn"eqpvkpwg"  
 vq"hwpevkqp"wpvkn"vjg" quekncvqt"htgswgpe { "Łpcnn { "tgcejgu"vjg" FCE" gpf r qkv0""Vjg"wpkv"ujqwnf"dg"tg/  
 wtpgf"vq"vjg" hcevt { "hqt" quekncvqt"tg rnceg o gpv"cv" { qwt"eqpxgpkpge0

Vjku"hcwnv"kp fkecvgu"vjcv"vjg" IRU"Tgegkxgt" jcu"pqv"dgpp"cdng"vq"ceswktg" c" IRU"uk i pcn" hqt"ppg" j qwt"  
 y jkng"vjg"Vk o g"Hki wtg"qh" Ogtkv" jcu"dgpp" ; . ""vjg"wpv { pe j tqpk | gf"eqpfkvkqp0""Vjku"eqwnf"dg"fwg"vq" c"  
 xctkv { "qh" tgcup0""Kh"vjgtg"ctg"pq"qvjgt"hcwnv"vjcv"eqwnf"gzrnckp"vjg"kpcknk { "vq"tgegkxg" c"uk i pcn."vjg"  
 vjgtg"eqwnf"dg"cp"cpvgppc" hcknwtg"qt"dnqemc i g0""Kh"vjg"eqpfkvkqp" rgtukuv"kp fgŁpkvgn { ."cpf" c" r tdnq o "  
 ykvj"vjg"cpvgppc"ku"pqv"gxkf gpv."vjgp"rngcug"eqpvcev"GpfTwp"Ewuvq o gt"Uwr r qtv0

Vjku"hcwnv"kp fkecvgu"vjcv"vjg" IRU"Tgegkxgt"ku"wpcdng"vq"eqpŁi wtg"vjg"HR I C0""Vjku"ku" c"hcvcn"hcwnv0"  
 Rngcug"eqpvcev"GpfTwp"Ewuvq o gt"Uwr r qtv0

Vjku"hcwnv"kp fkecvgu"vjcv"vjg" IRU"Tgegkxgt"ku"wpcdng"vq" xgthk { "c" y tkvg"vq"vjg" HNCUJ "ppq/xqncvkg"  
 rctc o gvt"uvqtc i g"ctgc0""Vjku"ujqwnf"pqv"gxgt"qeewt"wpfgt"pqt o cn"qrgtcvkqp0""Rngcug"eqpvcev"GpfTwp"  
 Ewuvq o gt"Uwr r qtv0

Vjku"hcwnv"kp fkecvgu"vjcv"vjg"nqecn" quekncvqt"u { pvjguk | gt" jcu"tgcejgf"vjg"cnct o "nk o kv0"Vjku"eqpfkvkqp"  
 ujqwnf"pqv"pqt o cnn { "qeewt"wpngu"vjg"wpkv"ku"uwlgevgf"vq"qww/qh/urgekŁecvkqp"gp xktqp o gpcn"eqpfk/  
 vkqp0""Qvjgt y kug."vjku"ku" c"hcvcn"hcwnv0""Rngcug"eqpvcev"GpfTwp"Ewuvq o gt"Uwr r qtv0  
 "

Vjku"hcwnv"kp fkecvgu"vjcv"vjg"nqecn" quekncvqt"u { pvjguk | gt" jcu"hcngf0""Vjku"eqpfkvkqp"ujqwnf"pqv"pqt/  
 o cnn { "qeewt"wpngu"vjg"wpkv"ku"uwlgevgf"vq"qww/qh/urgekŁecvkqp"gp xktqp o gpcn"eqpfkvkqp0""Qvjgt y kug."  
 vjku"ku" c"hcvcn"hcwnv0""Rngcug"eqpvcev"GpfTwp"Ewuvq o gt"Uwr r qtv0

Vjku"hcwnv"kp fkecvgu"vjcv"vjg" IRU"Tgegkxgt"tgegkxgf"cp"gttqpgqu"vk o g" kprwv"htq o "vjg" IRU"uk i pcnu0""Kh"  
 vjg"eqpfkvkqp" rgtukuv"rngcug"eqpvcev"GpfTwp"Ewuvq o gt"Uwr r qtv0

Vjku"hcwnv"kpfkceygu"vjcv"vjg"ockp"quekncvqt"jcu"hcngf0""Vjku"ku"c"hcvcn"hcwnv0""Rngcug"eqpvcev"GpfTwp"  
Ewuvqogt"Uwr rqtv0

Vjku"hcwnv"kpfkceygu"vjcv"vjg"IRU"cpvgppc"jcu"cp'qxgtewttgpn"eqpfkvkqp"\*ujqtv+0

Vjku"hcwnv"kpfkceygu"vjcv"vjg"IRU"cpvgppc"jcu"cp"wpfgtewttgpn"eqpfkvkqp"\*qrgp+0

Vjku"hcwnv"kpfkceygu"vjcv"vjg"tg"ku"cp"wpnqem"eqpfkvkqp"dgyvggp"vjg"tgegkxgt"quekncvqt"cpf"vjg"qvjgt"  
u{uvgo"vkogdcug"enqemu0""Vjku"ku"c"hcvcn"hcwnv0""Rngcug"eqpvcev"GpfTwp"Ewuvqogt"Uwr rqtv0







SPECIFICATIONS

U{pe"NGF<"C o dgt"NGF" rwnugu"vq"kp fkecvg" IRU"ceswkukvkqp"cpf"nqem"uvcvwu0  
 Cnct o "NGF<"Tgf"NGF"kp fkecvgu" c"hcwnv"eqpfkvkqp0

Uki pcn<"KIQ" rqt"cv" TU/454"ngxgnu" hqt"ugewtg."nqecn"vgt o kpcn"ceeguu0  
 Rctc o gygtu<"3;422"dcwf." : "fcvc"dkvu."pq" rctkv{."3"uvqr"dkv0  
 Eqppgevt<"Tgct/rcpgn"FD/; O"eqppgevt"ncdnggf"öTU/454ö0"  
 Vq"eqppgevt"vq" c"eq o r wvgt."c"pwnn/ o qfg o "cfc r vgt" o wuv"dg" wugf0""V jg"ugtken"ecdng" r tqxkfgf" ykvj"v jg"  
 u jkr o gpv"ku" yktgf"cu" c"pwnn/ o qfg o 0""Rkpqvv" hqt"v jg" TU/454"eqpuqng" rqt"ku" u j q y p" dgnq y 0  
 Pqvg<"Hqt"qrgtcvkqpcn" fgvccknu"ugg" 0

3	Pqv"Eqppgevgf
4	Tgegxg"Fcvc"*TZ+
5	Vtcpu o kv"Fcvc"*VZ+
6	Pqv"Eqppgevgf
7	I tqwpf
8	Pqv"Eqppgevgf
9	Pqv"Eqppgevgf
:	Pqv"Eqppgevgf
;	Pqv"Eqppgevgf

Ejcuuk<" " " " 3097öJ "z"3902öY "z"32097öF."3; ö"tce m o qwpv  
 Ygki jv<" " " " >" : "nd0"\*508"mi 0+  
 Cpvppc<" " " " 5047" J "z"502" fkc o gvt"\*u jkr r gf" chvgt" Oc{ "4239+0  
 " " " " " qt"  
 " " " " " 3097öJ "z"4047ö" fkc o gvt"\*u jkr r gf" dghqtg" Lwpg"4239+0

Qrgtcvkpi "Vg o rgtcvwtg<" " 2Å"vq" - 72Å"E  
 Uvqtcig"Vg o rgtcvwtg<" " /62Å"vq" - : 7Å"E  
 Cpvppc"Qrgtcvkpi "Vg o rgtcvwtg<" " /62Å"vq" - : 7Å"E  
 Qrgtcvkpi "J w o kfv{<" " 7 ' "vq"; 2 ' ."T J ."pqp/eqpf gpupki  
 Uvqtcig"J w o kfv{<" " 7 ' "vq"; 7 ' ."T J ."pqp/eqpf gpupki  
 Oczk o w o"Qrgtcvkpi "Cnvkwfvg<

Ugg" "hqt" o qtg" kphqt o cvkqp0  
Qrvkqpcn"RVRIKGGG/37: : "urgekhecvkqpu"ctg"nkuvfg"cdqxxg0  
Qrvkqpcn"IRU"Cpvgppc"Mkv"urgekhecvkqpu"ctg"nkuvfg"cdqxxg0

34"XFE"\*32/42"XFE+."802C" o czk o w o 0  
46"XFE"\*3;/58"XFE+."502C" o czk o w o 0  
6: "XFE"\*59/98"XFE+."402C" o czk o w o 0  
347"XFE"\*92/382"XFE+."302C" o czk o w o 0  
5/rqukvkqp"vgt okpcn"dnqem"qp"tgct/rcpgn<" - FE"KP."UCHGV [ "ITQWPF."/FE"KP  
\*Hnqcvkpi"rqygt"kprrw<"Gkvjgt"ö - ö"qt"ö/ö"ecp"dg"eqppgevgf"vq"gvctvj"i tqwpf0+  
Ugg" "hqt" o qtg" kphqt o cvkqp0

Cp{"eq o dkpcvkqp"qh"Wpkxgtucn"CE"cpflqt"FE"uwrrnkgu0  
Ugg" "hqt" o qtg" kphqt o cvkqp0

"Rqukvkxg"VVN"rwnug"kpqv"72 "qt"TU/644"ngxgnu0  
Ykfvj<"Wugt"ugngevcng"vq"42"wu."3"o u."322"o u."722"o u0  
Ceewtcef<">"52"pcpugeqpfu"TOU"vq"WVE\*WUPQ+"y jgp"nqemgf0,  
Uvcdknkv{<"VFGX">"42"pu." 7"ugeqpfu0  
Eqppgevt\*"VVN+<"Tgct/rcpgn"DPE"lcem"ncdngf"ö3RRUö0  
Eqppgevt\*"TU/644+<"Tgct/rcpgn"FD/; O"eqppgevt"ncdngf"ö3RRU"TU/644ö0  
Rkpqww\*"TU/644+<"Rkp"5"ku" - ukipcn0"Rkp"8"ku"/ukipcn0"Rkp"7"ku" I P F 0  
, Ugg"IRU/WVE"Vko kpi"Urgekhecvkqpu" hqt" fgvcnu0  
Pqv<"Vq"ejcpig"vjg"rwnug"y kfvj"tghgt"vq" 0

"3"XTOU"kpqv"72 .3"MJ|"ecttkt0  
Ukipcn<"C o rnkvwfg/oqfwncvgf\*"CO+."5<3"tcvkq0  
Hqto cv<"Wugt"ugngevcng"vq"KTKI/D"\*342IKGGG/3566."344."345+."PCUC/58."43590  
Eqppgevt<"Tgct/rcpgn"DPE"lcem"ncdngf"öCOEQFGö0  
Pqv<"Vq"ejcpig"vjg"vko g"eqfg" hqt o cv"tghgt"vq" 0

"Rqukvkxg"VVN"rwnug"kpqv"72 0  
Ukipcn<"VVN."FE/ujkhv0  
Hqto cv<"Wugt"ugngevcng"vq"KTKI/D"\*222IKGGG/3566."224."225+."PCUC/58."43590  
Eqppgevt<"Tgct/rcpgn"DPE"lcem"ncdngf"öFEEQFGö0  
Pqv<"Vq"ejcpig"vjg"vko g"eqfg" hqt o cv"tghgt"vq" 0

"Rqukvkxg"VVN"rwnug"kpqv"72 qp"DPE"lcem0  
Wugt/Ugngevcng"Qwvrvw"V{rg<"Qp/vko g"rwnug"tcvg0  
Tcvg<"Wugt"ugngevcng"vq"3."32."322."3M."32M."322M."3O."7O."32O"RRU."KRR0."3RR4U0  
Fwvf"Eng<"72 ' "gzegrv"3RRU"y jkej"oko keu"vjg"3RRU"Qwvrvw" fghkpgf"cdqxxg0  
Ceewtcef<">"32<sup>35</sup>"vq"WVE" hqt"46/jqwt"cxgtc ikpi"vko gu"y jgp"nqemgf0  
Uvcdknkv{<" { \* +>"32<sup>4</sup>;"hqt" ">"32<sup>4</sup>"ugeqpfu." { \* +>"32<sup>79</sup>l "hqt" "@32<sup>4</sup>"ugeqpfu0  
Eqppgevt<"Tgct/rcpgn"DPE"lcem"ncdngf"öRRQö0  
Pqv<"Vq"ejcpig"vjg"qwwrvw"ugngevkqp"tghgt"vq" 0





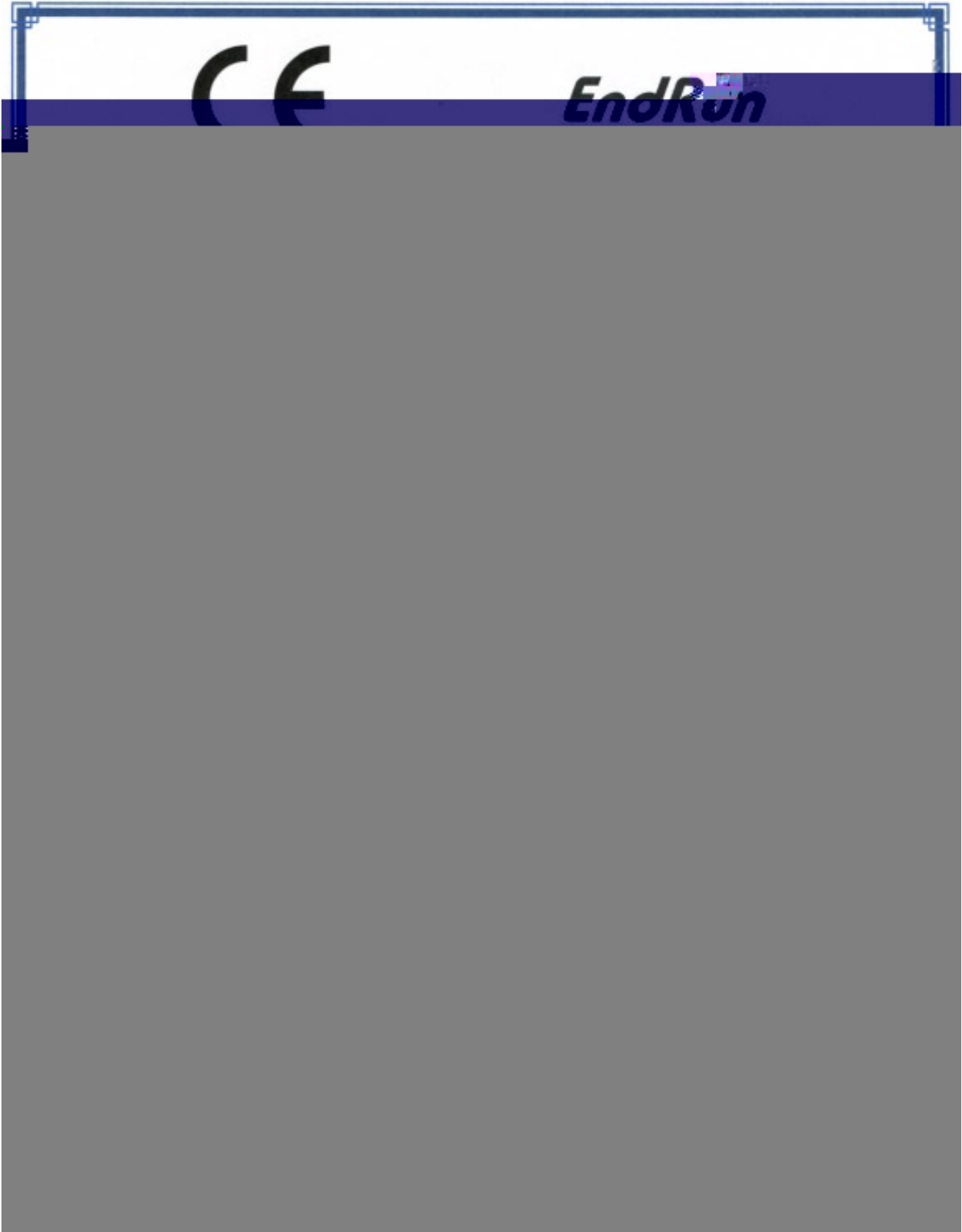

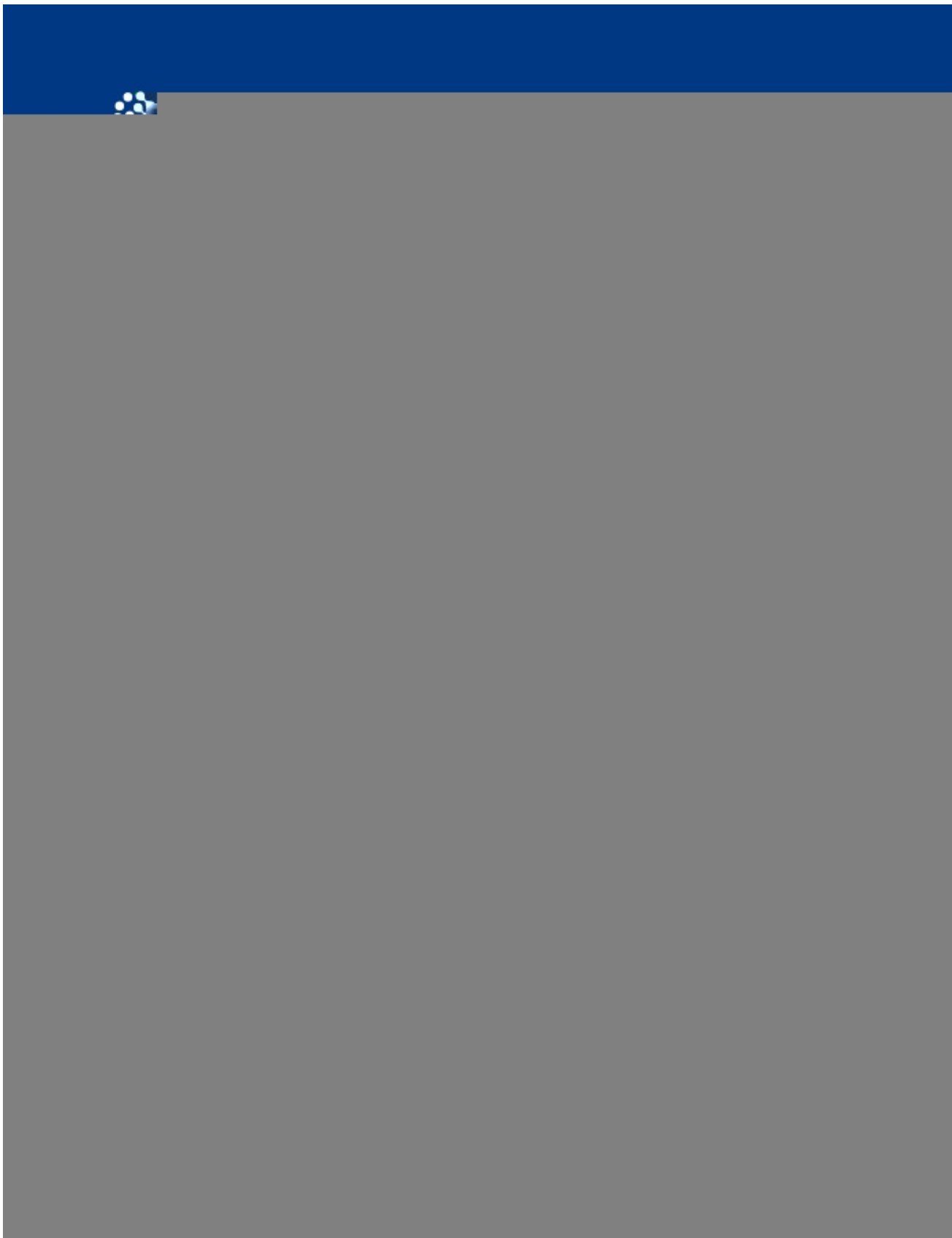





Vjku"rcig"kpvgpvkqpcm{"nghv"dncpm0



2270 Northpoint Parkway  
Santa Rosa, CA 95407